



# Technical catalogue 2021

## Enclosures



## Accessories



[uima-altaita.fi](http://uima-altaita.fi)

*Rentoudu vedessä*

[uima-altaita.fi](http://uima-altaita.fi)

*Rentoudu vedessä*

# Contents





History of ALBIXON .....	4	MIAMI .....	52
ALBIXON Portal .....	5	MONACO FUTURE .....	56
		SYDNEY .....	60
		Profiles and Rails .....	64
		Panels and Colours .....	67
		Panels .....	67
		Enclosure Details .....	66
		<b>Accessories</b> .....	<b>68</b>
		INVERBOOST PX HEAT PUMPS .....	70
		INVERBOOST C HEAT PUMPS .....	71
		XHPFD PLUS HEAT PUMPS .....	72
		Counterflow .....	73
		OXILIFE SALT DISPENSERS .....	74
		HIDROLIFE SALT DISPENSERS .....	76
		NEOSAL SALT DISPENSERS .....	78
		UV Lamps .....	79
		Circulation Pumps .....	80
		Water Filtration .....	81
		Pool Vacuum Cleaners .....	83
		Other Accessories .....	84
		Lighting .....	85
		<b>ALBIXON B2B</b> .....	<b>86</b>
		Sales Arguments .....	88
		Enclosure Logistics .....	90
<b>Pool Enclosures</b> .....	<b>26</b>		
CASABLANCA INFINITY .....	28		
CASABLANCA .....	32		
DALLAS/DALLAS CLEAR.....	36		
DALLAS WALL-MOUNTED .....	40		
KLASIK/KLASIK CLEAR .....	44		
KLASIK PRO/KLASIK PRO CLEAR .....	48		



# The history of ALBIXON

## Company Mission

We bring pleasant experiences, active relaxation and joyful moments for your family and loved ones into your gardens.

## Company values

-  Quality is our priority
-  We are fair and open
-  We are team players
-  We are professionals
-  We care about ALBIXON
-  We are continually improving

# ALBIXON

Global leader of the swimming pool industry

- Market presence since 1990
- Leading manufacturer of swimming pools and enclosures in Europe
- Production capacity of 5,000 swimming pools and 10,000 enclosures per year
- 450 highly qualified employees
- More than 50,000 square meters of production and storage areas
- Development and design centre with an area of 1 500 m<sup>2</sup>
- Use of advanced technology and top-quality materials
- Owner of dozens of patents and international quality certificates
- Biggest powder coating shop in Central Europe, using the unique Decoral technology

## Company vision

We want to be a credible European leader in producing innovative and technologically advanced products related to the economical use of water for active recreation.

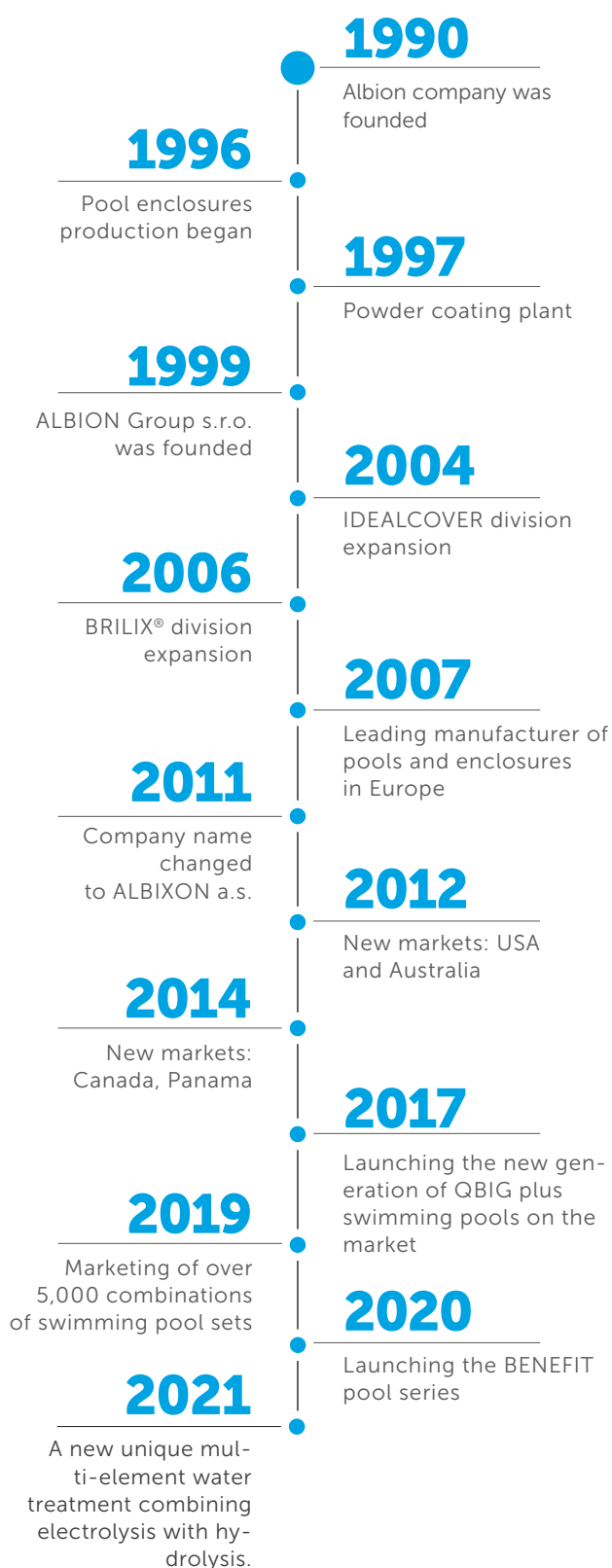

# ALBIXON portal

**Everything you need for a comfortable way of doing business at one place.**

- ✓ All information about products
- ✓ Instant quotation
- ✓ Easy choice of the most suitable options for the customer
- ✓ Intuitive control
- ✓ Automatically generated technical drawings
- ✓ Partner benefits for everyone

ALBIXONPORTAL.COM



- ✓ Easy and transparent purchase orders
- ✓ Warranty claims and spare parts
- ✓ Marketing and product materials in one place

Register now at  
[www.ALBIXONPORTAL.com](http://www.ALBIXONPORTAL.com)



# Enclosures

You can find out all about enclosures on pages 26–67



**BRILIX®**

You can find out all about BRILIX accessories on pages 68–85

# Enclosures









[uima-altaita.fi](http://uima-altaita.fi)



*Rentoudu vedessä*

# Casablanca Infinity

If you are intrigued by discreet and sophisticated shapes, CASABLANCA INFINITY is just the thing for you! This low enclosure, which makes a very discreet first impression in the garden, hides many secrets to attract everybody's attention. Its angular clear roofing material, futuristic carbon design and low Air rails are the best evidence.



# CASABLANCA INFINITY series

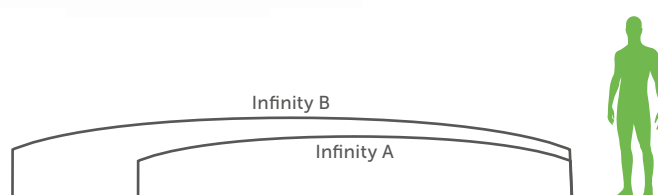
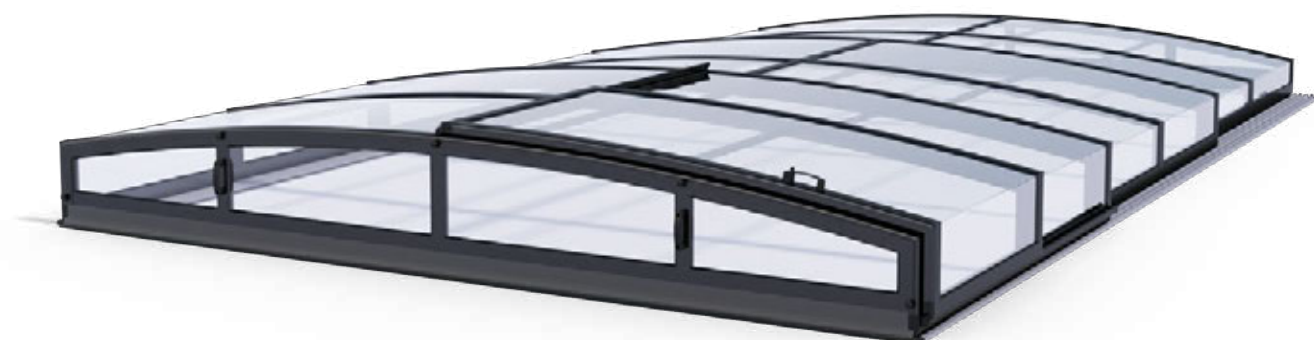

Specifications	Casablanca Infinity A	Casablanca Infinity B
Maximum covered area	346 x 635 cm	442 x 850 cm
Number of modules	3	4
Outer width "B"	390 cm	500 cm
Outer width "A"	362 cm	458 cm
Outer length "E"	646 cm	860 cm
Outer height "V"	55 cm	70 cm
Side entrance	✓	✓
Module panels	PK4 <sup>1)</sup>	PK4 <sup>1)</sup>
Front head	removable	removable
Front head panels	PK4 <sup>1)</sup>	PK4 <sup>1)</sup>
Rear head	fixed	fixed
Rear head panels	PK4 <sup>1)</sup>	PK4 <sup>1)</sup>
Higher lower edge of heads	9.5 cm	9.5 cm
Supporting profiles	L+	L+
Track	AIR double-sided/single-sided <sup>2)</sup>	
Module locking	unlockable/lockable <sup>3)</sup>	
Colour	Carbon, DB703 <sup>4)</sup>	Carbon, DB703 <sup>4)</sup>
BOX package size	445 x 48 x 127 cm	561 x 55 x 127 cm
BOX package weight	440 kg/415 kg <sup>5)</sup>	675 kg/650 kg <sup>5)</sup>

<sup>1)</sup> PK4 – transparent solid polycarbonate with a thickness of 4 mm with UV protection.

<sup>2)</sup> The left/right position of the track is determined when looking at the largest module from the front. The track is not sunk into the ground. Each module has its own track.

<sup>3)</sup> The enclosure with a single-sided rail is equipped with lockable devices on the railless side.

<sup>4)</sup> The enclosure with a single-sided rail is always supplied in Karbon finish.

<sup>5)</sup> Weights: double-rail version/single-rail version.

## Luxurious colour design

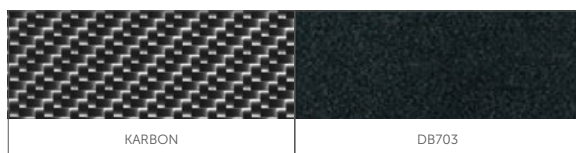

## Main advantages of ALBIXON BOX

- ➔ Goods for immediate dispatch
- ➔ Quick and easy installation
- ➔ Packaging variability

# CASABLANCA INFINITY

## custom (2 rails)

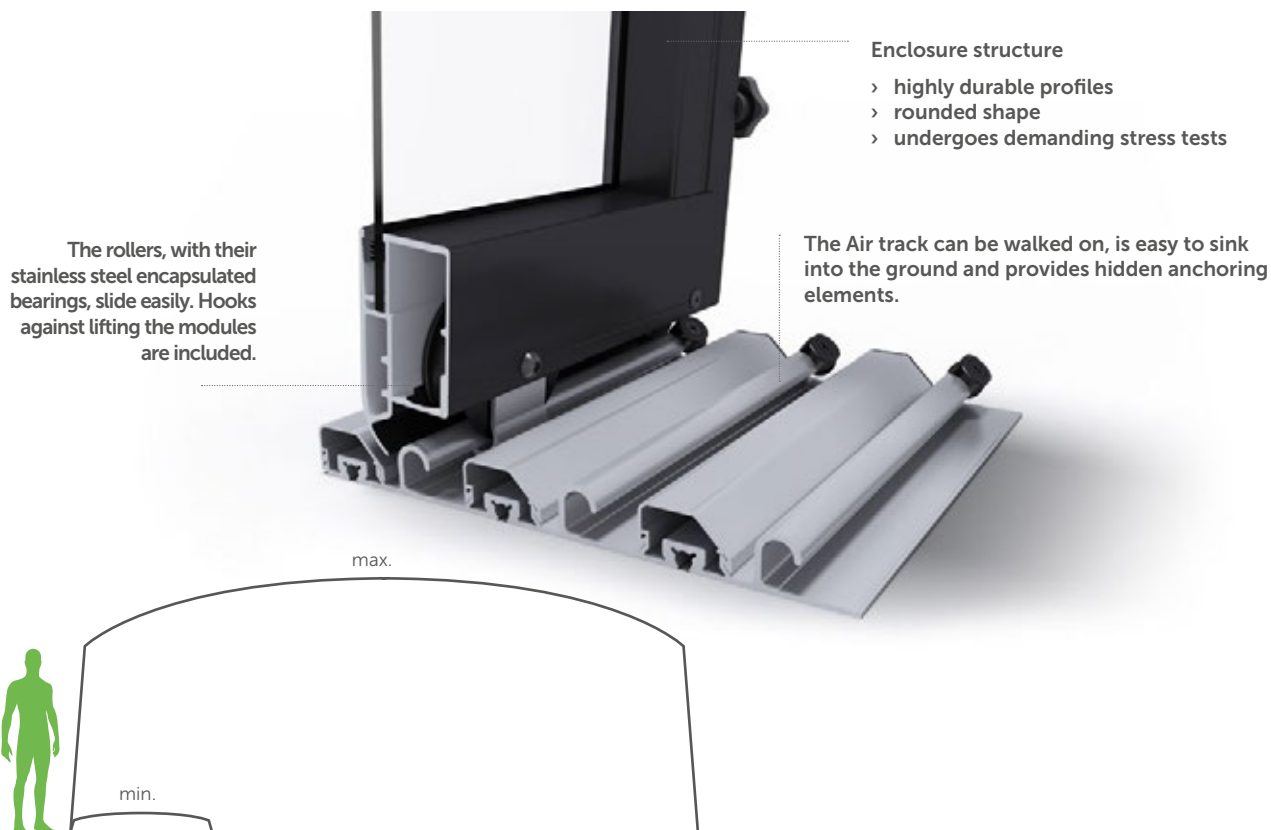

Custom Casablanca Infinity – possible dimensions								
outer width up to (cm)	profile type	minimum height for the specified number of modules (cm)						
		1 module	2 modules	3 modules	4 modules	5 modules	6 modules	7 modules
151-200	L	38	44	50	56	62	68	74
250	L	42	48	54	60	66	72	78
300	L	45	51	57	63	69	75	81
350	L	48	54	60	66	72	78	84
400	L	51	57	63	69	75	81	87
450	L	55	61	67	73	79	85	91
500	L	58	64	70	76	82	88	94
550	L+	61	67	73	79	85	91	97
600	L+	65	71	77	83	89	95	101
650	XL	81	91	101	110	120	128	137
700	XL	85	94	104	113	123	132	140
750	XL	88	98	107	117	126	135	143
800	XL	91	101	110	120	130	138	147
850	XL	95	104	114	123	133	141	150

All modules with PK4 panels (transparent solid polycarbonate, clear/smoky, thickness of 4 mm with UV protection)

### Wide range of colours



### Custom production options

- ➔ Custom dimensions of enclosure
- ➔ Selection of the panel colour
- ➔ Always consult the manufacturer for the type and location of the door
- ➔ Completely individual configuration
- ➔ Choice of more than 40 colours and patterns of the supporting structure



[uima-altaita.fi](http://uima-altaita.fi)



*Rentoudu vedessä*

# CASABLANCA

The CASABLANCA enclosure – a dominant landmark of your garden. It is not only an elegant enclosure for your pool, but also a space for versatile use. You no longer need to have any worries about the weather when you want to have some fun with your friends by the pool.



# CASABLANCA

custom

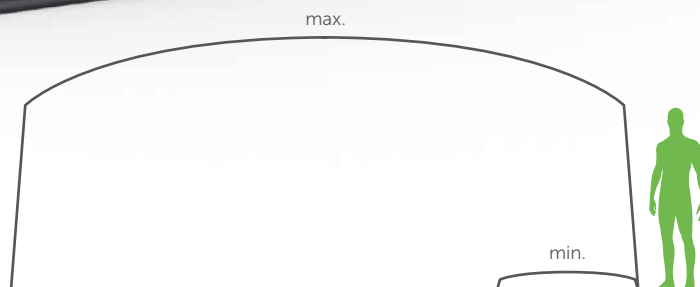

Custom-made Casablanca – possible dimensions

outer width up to (cm)	profile type	minimum height for the specified number of modules (cm)						
		1 module	2 modules	3 modules	4 modules	5 modules	6 modules	7 modules
151-200	L	38	44	50	56	62	68	74
250	L	42	48	54	60	66	72	78
300	L	45	51	57	63	69	75	81
350	L	48	54	60	66	72	78	84
400	L	51	57	63	69	75	81	87
450	L	55	61	67	73	79	85	91
500	L	58	64	70	76	82	88	94
550	L+	61	67	73	79	85	91	97
600	L+	65	71	77	83	89	95	101
650	XL	81	91	101	110	120	128	137
700	XL	85	94	104	113	123	132	140
750	XL	88	98	107	117	126	135	143
800	XL	91	101	110	120	130	138	147
850	XL	95	104	114	123	133	141	150

Panels: **PK4** (transparent solid polycarbonate, clear/smoky, with a thickness of 4 mm with UV protection – for all profiles used) **PK8** (tube clear/smoke polycarbonate with a thickness of 8 mm with UV protection – for L and L+ profiles). **PK10** (tube clear/smoke polycarbonate with a thickness of 10 mm with UV protection – for XL profiles). In the case of XL profiles, the heads are always made of PK 8-mm or PK4 panels.

### Wide range of colours



### Custom production options

- ➔ Custom dimensions of enclosure
- ➔ Selection of the panel type and colour
- ➔ Always consult the manufacturer for the type and location of the door
- ➔ Completely individual configuration
- ➔ Choice of more than 40 colours and patterns of the supporting structure

# CASABLANCA without rails

## custom

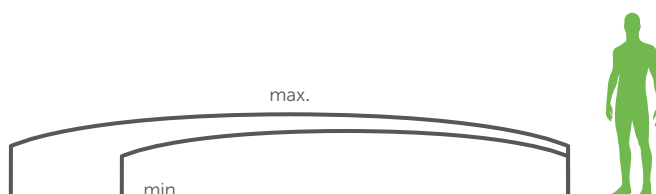

Custom-made Casablanca without rails – possible dimensions								
outer width up to (cm)	profile type	minimum height for the specified number of modules (cm)						
		1 module	2 modules	3 modules	4 modules	5 modules	6 modules	7 modules
151-200	L+	33	39	46	52	58	65	71
250	L+	35	41	48	54	60	67	73
300	L+	37	43	50	56	63	69	75
350	L+	39	46	52	58	65	71	78
400	L+	41	48	54	61	67	73	80
450	L+	44	50	56	63	69	76	82
500	L+	46	52	58	65	71	78	84

All modules with PK4 panels only (transparent solid polycarbonate, clear/smoky, with a thickness of 4 mm with UV protection)

Optional single-rail version with the rail on the left/right side for each enclosure module.

The left/right position of the rail is determined when looking at the largest enclosure module from the front.

### Wide range of colours



according to the current sample book

### Custom production options

- ➔ Custom dimensions of enclosure
- ➔ Selection of the panel type and colour
- ➔ Side entrance only.
- ➔ Completely individual configuration
- ➔ Choice of more than 40 colours and patterns of the supporting structure





[uima-altaita.fi](http://uima-altaita.fi)



*Rentoudu vedessä*

# DALLAS

# DALLAS CLEAR

If you like round shapes and graceful curves the DALLAS pool enclosure is the best solution for you. Thanks to its elegant design, this enclosure is one of the most popular shapes and fits into any garden.

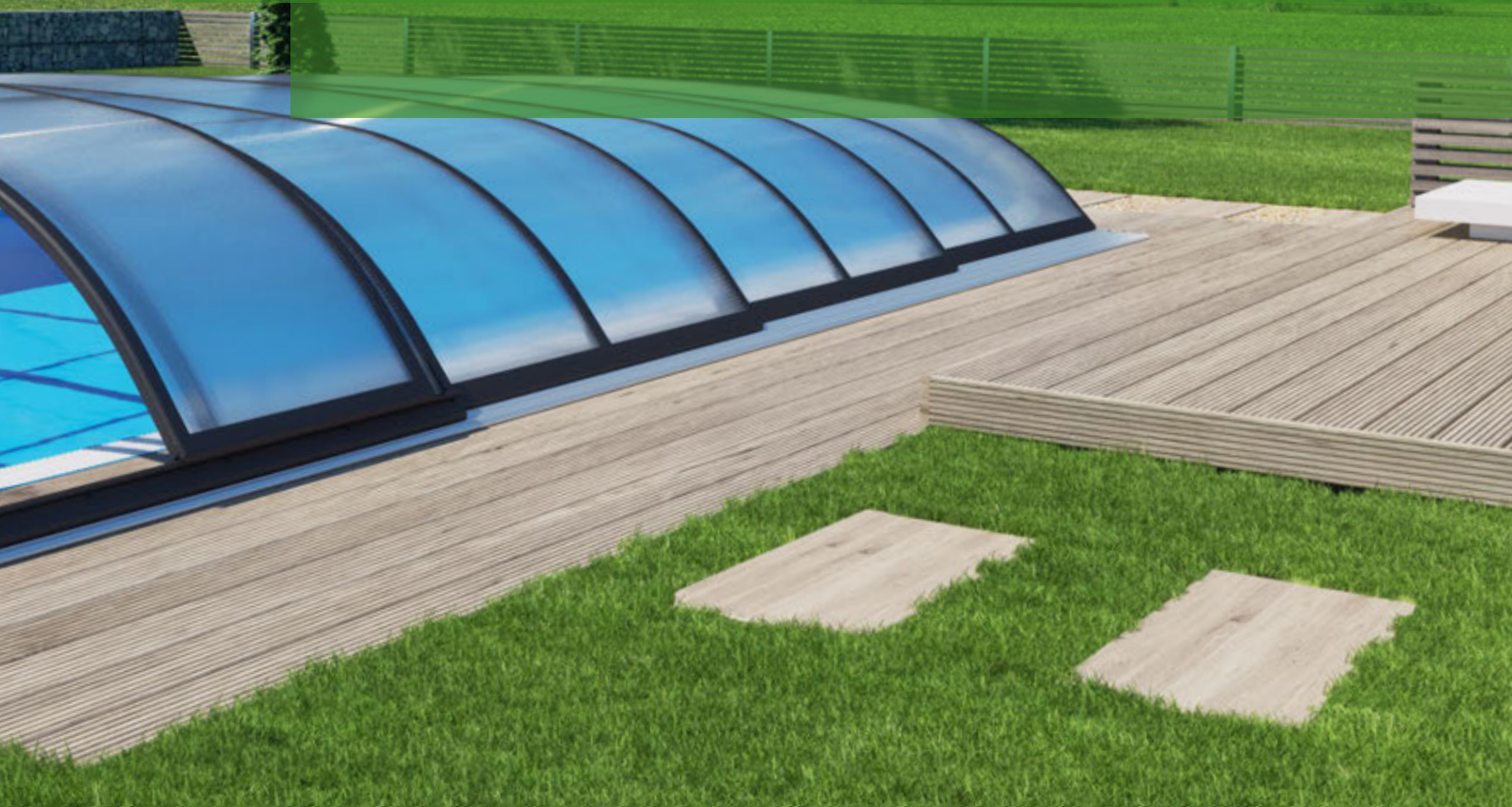

# DALLAS/DALLAS CLEAR

## serial

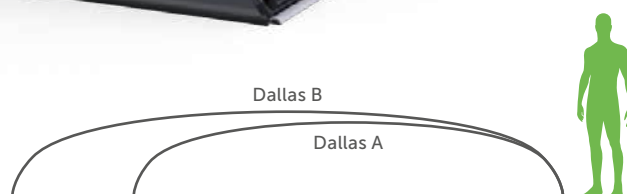

Model	Dallas A	Dallas Clear A	Dallas B	Dallas Clear B
Maximum covered area	363 x 635 cm		462 x 850 cm	
Number of modules	3	3	4	4
Outer width "B"	407 cm	407 cm	520 cm	520 cm
Outer width "A"	379 cm	379 cm	478 cm	478 cm
Outer length "E"	646 cm	646 cm	860 cm	860 cm
Outer height "V"	82 cm	82 cm	100 cm	100 cm
Side entrance	✓	✓	✓	✓
Module panels	PK8 <sup>1)</sup>	PK4 <sup>2)</sup>	PK8 <sup>1)</sup>	PK4 <sup>2)</sup>
Front head	removable	removable	removable	removable
Front head panel	PK8 <sup>1)</sup>	PK4 <sup>2)</sup>	PK8 <sup>1)</sup>	PK4 <sup>2)</sup>
Rear head	fixed	fixed	fixed	fixed
Rear head panel	PK8 <sup>1)</sup>	PK4 <sup>2)</sup>	PK8 <sup>1)</sup>	PK4 <sup>2)</sup>
Higher lower edge of heads	9.5 cm	9.5 cm	9.5 cm	9.5 cm
Supporting profiles	M	M	L	L
Track	AIR double-sided			
Module locking	unlockable/lockable			
Colour	Silver Elox, DB703			
BOX package size	445 x 48 x 127 cm		561 x 55 x 127 cm	
BOX package weight	310 kg	420 kg	480 kg	650 kg

<sup>1)</sup> PK8 – transparent tube polycarbonate with a thickness of 8 mm with UV protection.

<sup>2)</sup> PK4 – transparent solid polycarbonate with a thickness of 4 mm with UV protection.

### Two colour versions

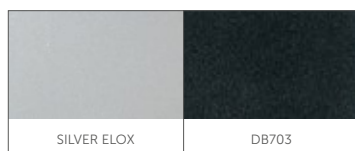

### Main advantages of ALBIXON BOX

- ➔ Goods for immediate dispatch
- ➔ Quick and easy installation
- ➔ Packaging variability

# DALLAS/DALLAS CLEAR

## custom

### Enclosure construction

- > Highly resistant profiles
- > Rounded shape
- > Intensive stress tests successfully achieved

Wheels with stainless steel sealed bearings are easy to move. It includes hooks to prevent lifting the modules.

Air rails are easy to embed into the ground, are fully walkable and the anchoring elements are hidden.

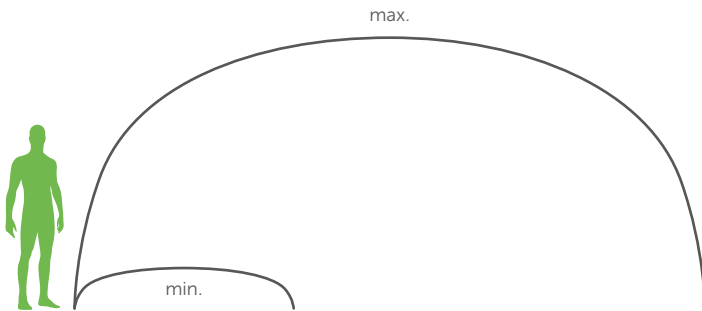

Custom Dallas/Dallas Clear – possible dimensions								
outer width up to (cm)	profile type	minimum height for the specified number of modules (cm)						
		1 module	2 modules	3 modules	4 modules	5 modules	6 modules	7 modules
301-350	M	64	69	75	80	86	–	–
400	M	69	74	79	84	89	94	100
450	M	72	77	82	86	91	97	102
500	L	81	85	89	94	98	103	108
550	L	88	92	96	100	105	109	114
600	L+	98	101	105	108	112	116	121
650	XL	136	144	153	162	171	180	189
700	XL	141	149	157	165	174	182	191
750	XL	146	154	162	170	178	186	194
800	XL	153	160	167	175	183	191	199

All modules with PK4 panels (transparent solid polycarbonate, clear/smoky, with a thickness of 4 mm with UV protection) or PK8 (tube polycarbonate, clear/smoky, with a thickness of 8 mm with UV protection)

### Wide range of colours



### Custom production options

- ➔ Custom dimensions of enclosure
- ➔ Selection of the panel type and colour
- ➔ Always consult the manufacturer for the type and location of the door
- ➔ Completely individual configuration
- ➔ Choice of more than 40 colours and patterns of the supporting structure



# DALLAS WALL-MOUNTED

How to best cover a swimming pool located near a wall?  
The solution is DALLAS on the wall, which offers you  
an unexpected amount of space in a small area.



[uima-altaita.fi](http://uima-altaita.fi)



*Rentoudu vedessä*

# DALLAS Wall-Mounted

custom

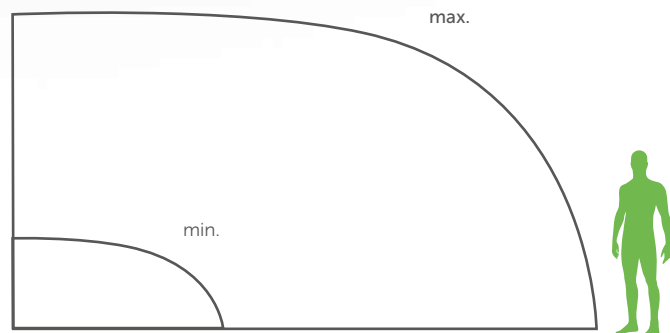

Custom Dallas wall-mounted – possible dimensions								
outer width up to (cm)	profile type	minimum height for the specified number of modules (cm)						
		1 module	2 modules	3 modules	4 modules	5 modules	6 modules	7 modules
201-250	L	90	97	104	111	118	125	132
300	L	95	102	109	116	123	130	137
350	L	100	107	114	121	128	135	142
400	L	105	112	119	126	133	140	147
450	L	110	117	124	131	138	145	152
500	L+	115	122	129	136	143	150	157
550	L+	120	127	134	141	148	155	162

Custom production based on professional surveying at the installation site

## Wide range of colours



## Custom production options

- ➔ Custom dimensions of enclosure
- ➔ Selection of the panel type and colour
- ➔ Always consult the manufacturer for the type and location of the door
- ➔ Completely individual configuration
- ➔ Choice of more than 40 colours and patterns of the supporting structure

# DALLAS Wall-Mounted

custom

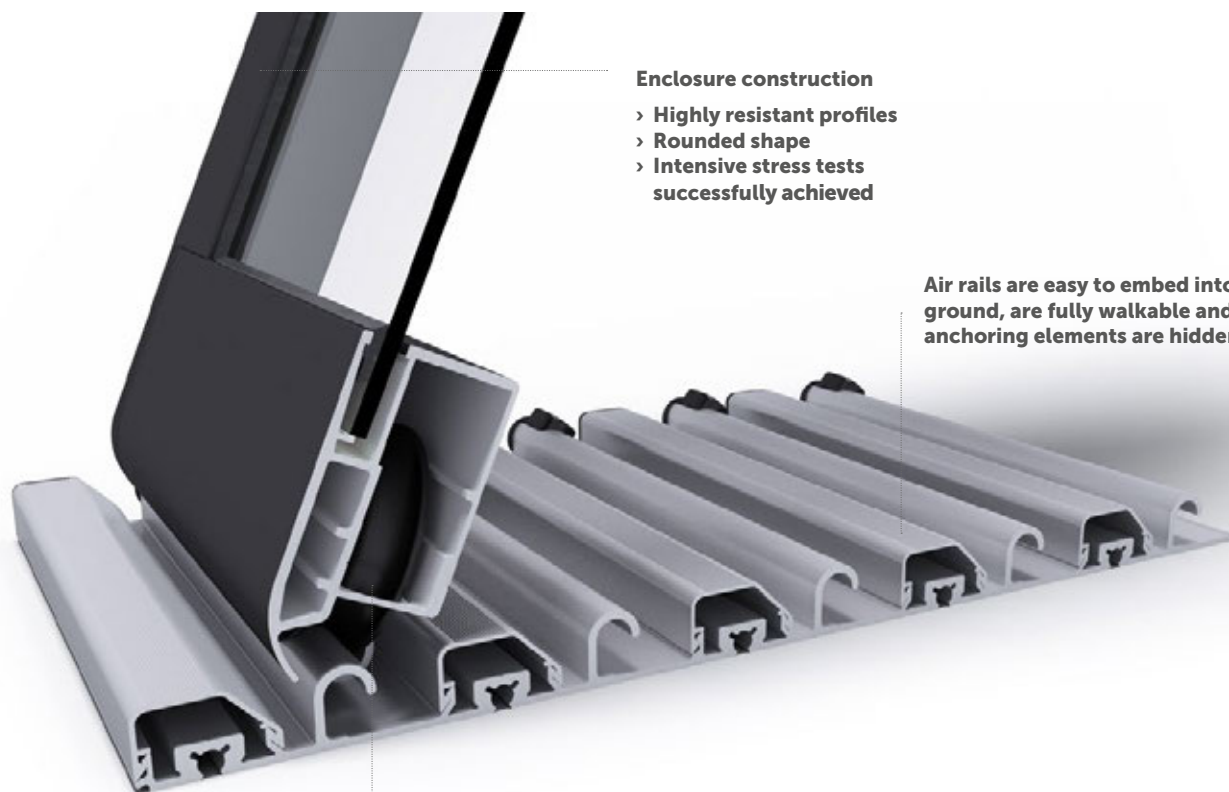

#### Enclosure construction

- › Highly resistant profiles
- › Rounded shape
- › Intensive stress tests successfully achieved

Air rails are easy to embed into the ground, are fully walkable and the anchoring elements are hidden.

Wheels with stainless steel sealed bearings are easy to move. It includes hooks to prevent lifting the modules.

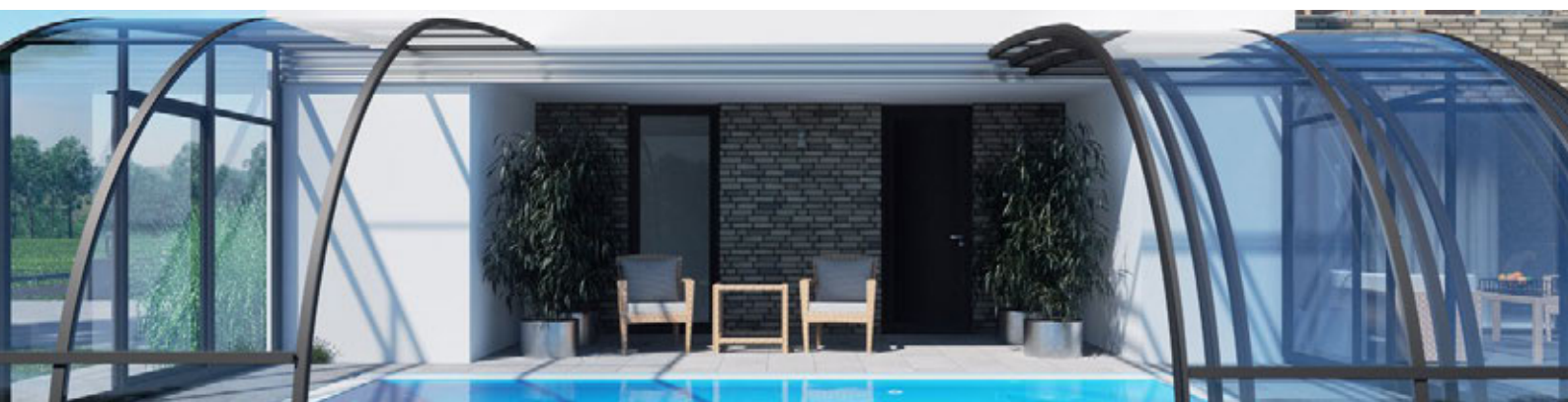





# KLASIK

# KLASIK CLEAR

An enclosure of medium height suitable for everyone, a traditional product you will never stop enjoying... that is our KLASIK enclosure. Choose an enclosure that will serve you for many years.

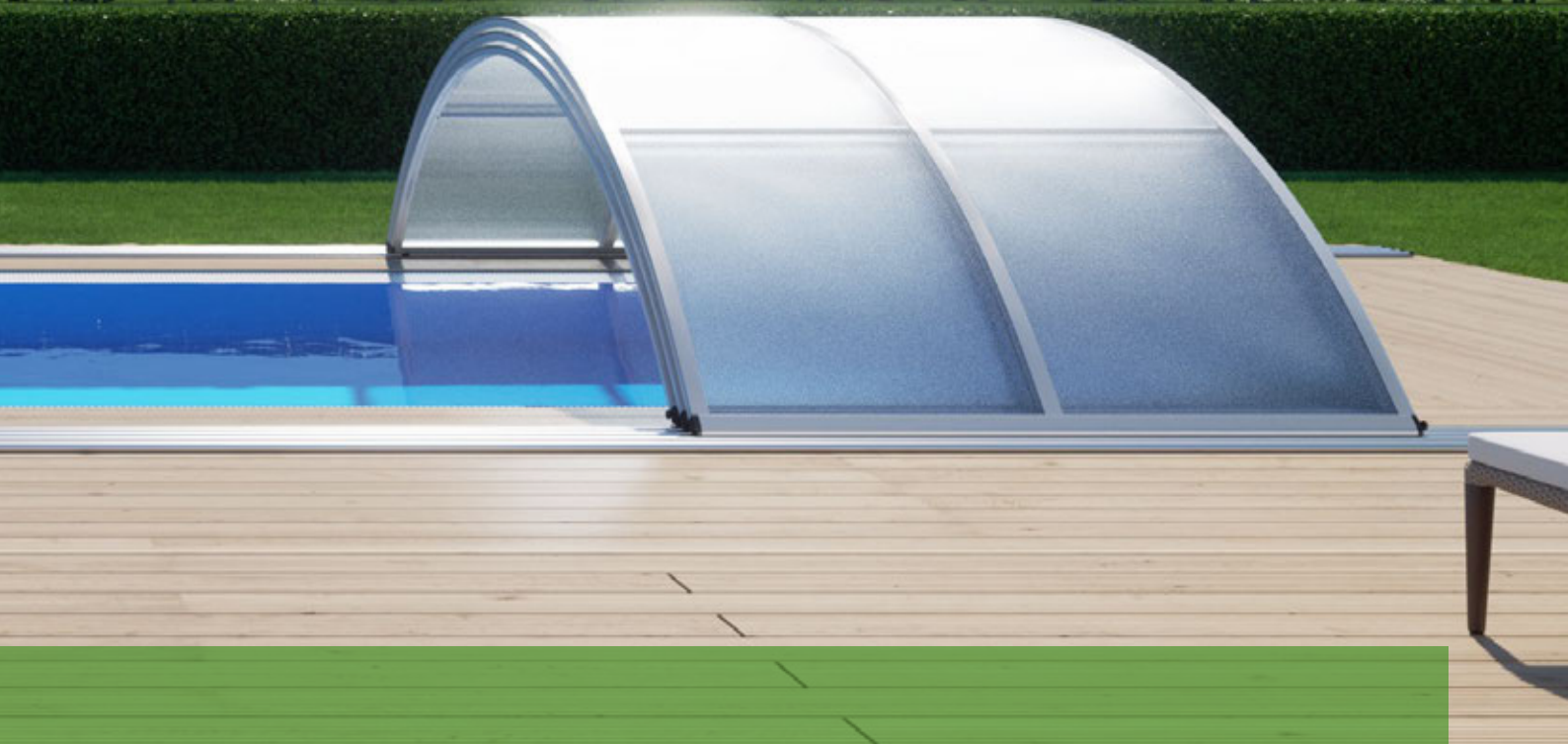

# KLASIK/KLASIK CLEAR

## serial

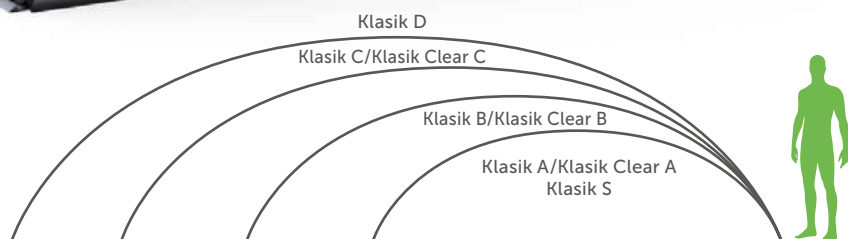

Model	Klasik S	Klasik A	Klas. Clear A	Klasik B	Klas. Clear B	Klasik C	Klas. Clear C	Klasik D
Maximum covered area	317 x 420 cm	317 x 635 cm		413 x 850 cm		499 x 1060 cm		564 x 1276 cm
Number of modules	2	3	3	4	4	5	5	6
Outer width "B"	361 cm	361 cm	361 cm	471 cm	471 cm	571 cm	571 cm	650 cm
Outer width "A"	347 cm	333 cm	333 cm	429 cm	429 cm	515 cm	515 cm	580 cm
Outer length "E"	433 cm	646 cm	646 cm	860 cm	860 cm	1073 cm	1073 cm	1286 cm
Outer height "V"	100 cm	100 cm	100 cm	130 cm	130 cm	155 cm	155 cm	175 cm
Side entrance	✓	✓	✓	✓	✓	✓	✓	✓
Module panels	PK8 <sup>1)</sup>	PK8 <sup>1)</sup>	SAN <sup>2)</sup>	PK8 <sup>1)</sup>	SAN <sup>2)</sup>	PK8 <sup>1)</sup>	SAN <sup>2)</sup>	PK8 <sup>1)</sup>
Front head	removable	removable	removable	removable	removable	removable	removable	removable
Front head panels	PK8 <sup>1)</sup>	PK8 <sup>1)</sup>	SAN <sup>2)</sup>	PK8 <sup>1)</sup>	SAN <sup>2)</sup>	PK8 <sup>1)</sup>	SAN <sup>2)</sup>	PK8 <sup>1)</sup>
Rear head	fixed	fixed	fixed	fixed	fixed	fixed	fixed	fixed
Rear head panels	PK8 <sup>1)</sup>	PK8 <sup>1)</sup>	SAN <sup>2)</sup>	PK8 <sup>1)</sup>	SAN <sup>2)</sup>	PK8 <sup>1)</sup>	SAN <sup>2)</sup>	PK8 <sup>1)</sup>
Higher lower edge of heads	9.5 cm	9.5 cm	9.5 cm	9.5 cm	9.5 cm	9.5 cm	9.5 cm	9.5 cm
Supporting profiles	M	M	M	M	M	L	L	L
Track	AIR double-sided							
Module locking	unlockable/lockable							
Colour	DB703	Silver Elox, DB703						DB703
BOX package size	430 x 41 x 157 cm			563 x 47 x 188 cm		606 x 61 x 175 cm		680 x 85 x 200 cm
BOX package weight	240 kg	290 kg	380 kg	470 kg	600 kg	680 kg	860 kg	890 kg

<sup>1)</sup> PK8 – transparent tube polycarbonate with a thickness of 8 mm with UV protection

<sup>2)</sup> SAN – transparent panel with a thickness of 4 mm

### Two colour versions



### Main advantages of ALBIXON BOX

- ➔ Goods for immediate dispatch
- ➔ Quick and easy installation
- ➔ Packaging variability

# KLASIK / KLASIK CLEAR

## custom

### Enclosure construction

- > Highly resistant profiles
- > Rounded shape
- > Intensive stress tests successfully achieved

Wheels with stainless steel sealed bearings are easy to move. It includes hooks to prevent lifting the modules.

Air rails are easy to embed into the ground, are fully walkable and the anchoring elements are hidden.

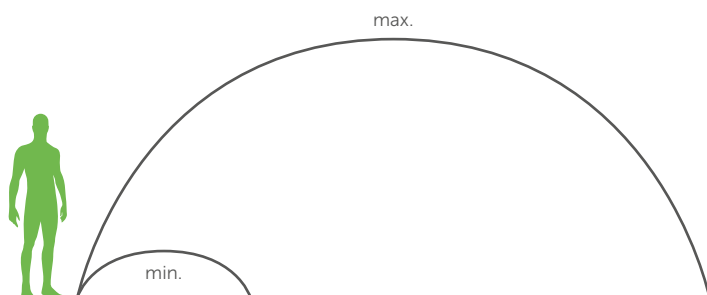
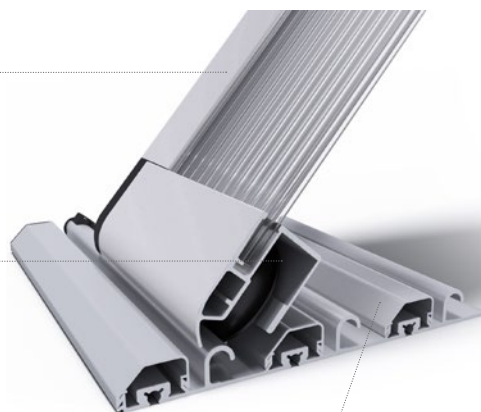

Custom Klasik/Klasik Clear - possible dimensions								
outer width up to (cm)	profile type	minimum height for specified number of modules (cm)						
		1 module	2 modules	3 modules	4 modules	5 modules	6 modules	7 modules
300	M	80	85	85	90	95	95	100
350	M	90	95	95	100	105	105	110
400	M	105	105	110	110	115	115	120
450	M	115	115	120	120	125	125	130
500	M	125	125	130	130	135	140	140
550	L	135	140	140	145	145	150	150
600	L	145	150	150	155	155	160	160
650	L	160	160	165	165	170	170	175
700	XL	185	205	205	220	225	225	230
750	XL	195	220	230	235	235	240	245
800	XL	210	230	235	245	250	255	260
850	XL	245	250	255	260	265	270	270
900	XL	260	265	270	270	275	280	280

### Wide range of colors



### Custom production options

- ➔ Individual enclosure sizes
- ➔ Choice of roofing material type and color
- ➔ Door type and location as per your request
- ➔ Individual configuration
- ➔ Wide range of over 40 colors and decors of the supporting structure

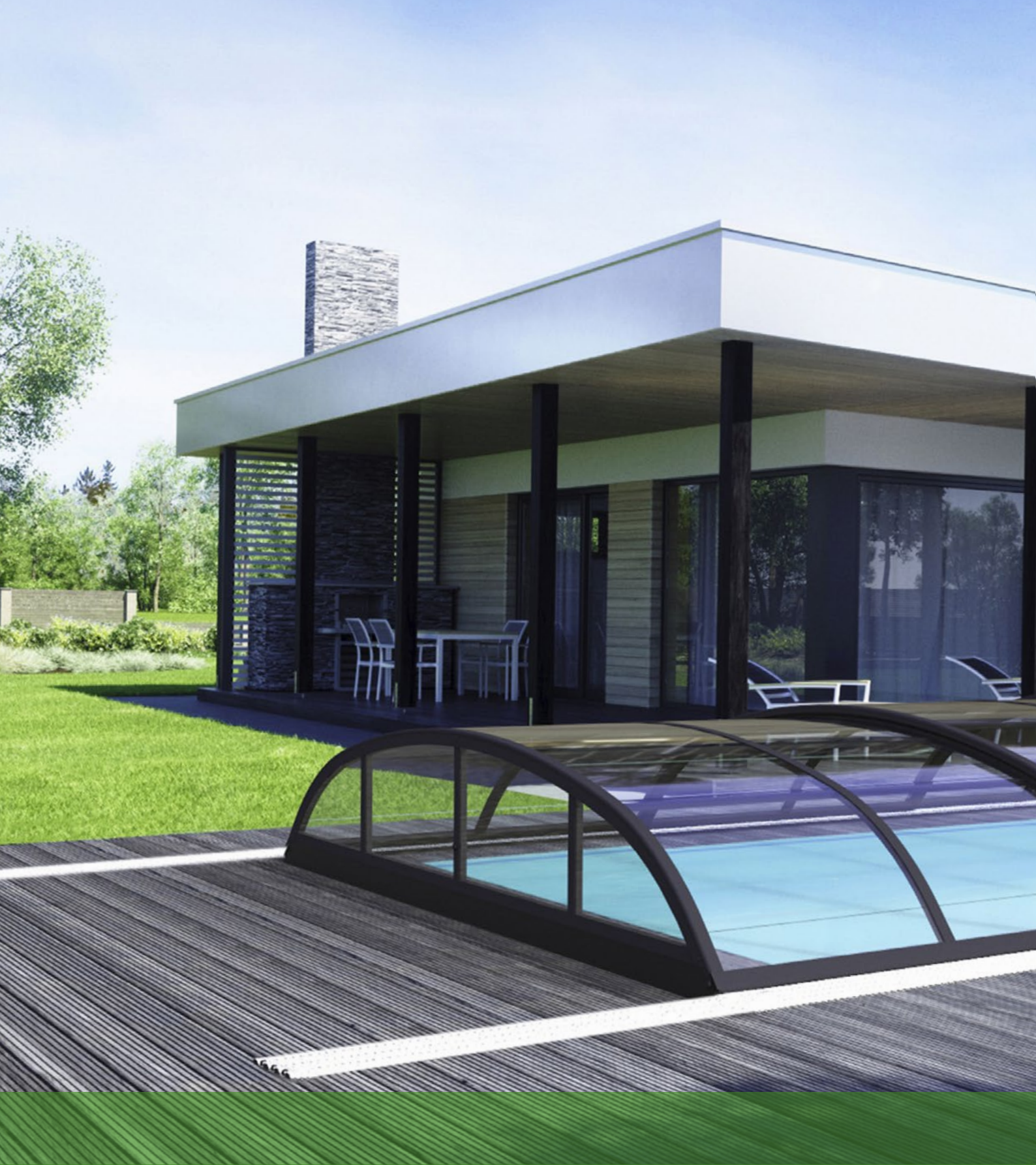

[uima-altaita.fi](http://uima-altaita.fi)



*Rentoudu vedessä*

# KLASIK PRO

# KLASIK PRO CLEAR

We would like to present to you a model from the ALBIXON BOX series, the KLASIK PRO enclosure. Just to avoid confusion, this is really a KLASIK enclosure. Large enclosed area, minimum height, maximum resistance to snow load, easy and fast installation – these are the significant advantages of the KLASIK PRO enclosure. What you will appreciate is the low profile and elegant lines.

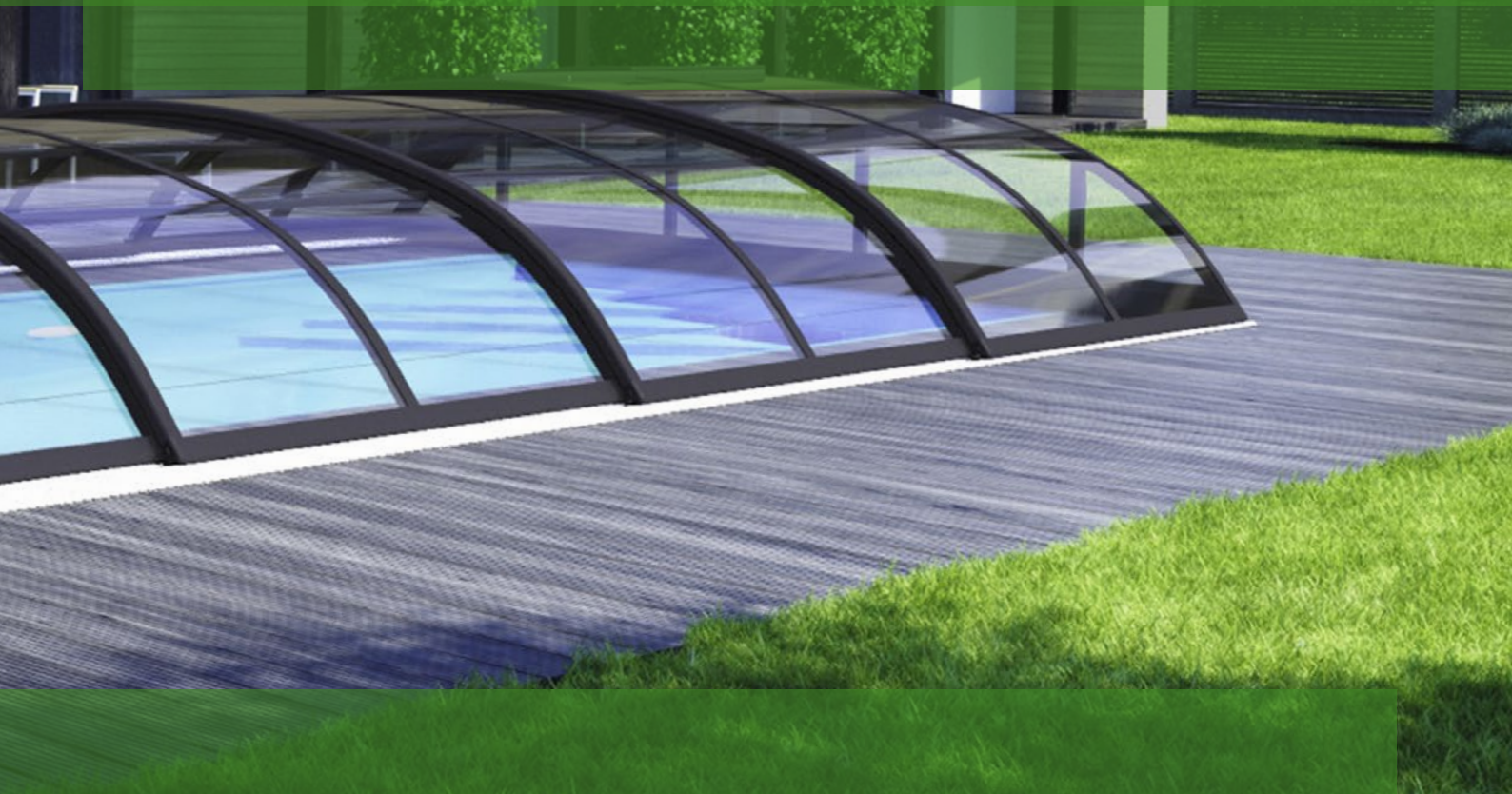

# KLASIK PRO/KLASIK PRO CLEAR

## serial



Klasik Pro B/Klasik Pro Clear B



Model	Klasik Pro B	Klasik Pro Clear B
Maximum covered area	413 x 850 cm	413 x 850 cm
Number of modules	4	4
Outer width "B"	471 cm	471 cm
Outer width "A"	429 cm	429 cm
Outer length "E"	860 cm	860 cm
Outer height "V"	100 cm	100 cm
Side entrance	✓	✓
Module panels	PK8 <sup>1)</sup>	PK4 <sup>2)</sup>
Front head	removable	removable
Front head panel	PK8 <sup>1)</sup>	PK4 <sup>2)</sup>
Rear head	fixed	fixed
Rear head panel	PK8 <sup>1)</sup>	PK4 <sup>2)</sup>
Higher lower edge of heads	9.5 cm	9.5 cm
Supporting profiles	L	L
Track	AIR double-sided	
Module locking	unlockable/lockable	
Colour	DB703	DB703
BOX package size	561 x 55 x 127 cm	561 x 55 x 127 cm
BOX package weight	470 kg	610 kg

<sup>1)</sup> PK8 – transparent tube polycarbonate with a thickness of 8 mm with UV protection.

<sup>2)</sup> PK4 = transparent clear polycarbonate with a thickness of 4-mm with UV protection

# KLASIK PRO

standard



#### Enclosure construction

- › Highly resistant profiles
- › Rounded shape
- › Intensive stress tests successfully achieved

Wheels with stainless steel sealed bearings are easy to move. It includes hooks to prevent lifting the modules.

Air rails are easy to embed into the ground, are fully walkable and the anchoring elements are hidden.

#### Elegant color design



DB703

#### ALBIXON BOX main advantages

- ➔ Goods ready for shipment
- ➔ Quick and easy assembly
- ➔ Packaging variability





# MIAMI

Quality without compromise, unique colors and high durability. All of this is MIAMI enclosure which we produce 100% to order. It will fulfill all your most secret wishes.



# MIAMI

custom

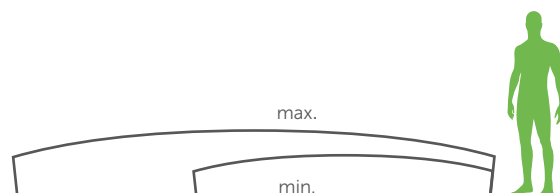

Custom Miami – possible dimensions								
outer width up to (cm)	profile type	minimum height for the specified number of modules						
		1 module	2 modules	3 modules	4 modules	5 modules	6 modules	7 modules
401-450	XL	62	72	82	92	102	112	122
500	XL	64	74	84	94	104	114	124
550	XL	67	77	87	97	107	117	127
600	XL	69	79	89	99	109	119	129
650	XL	71	81	91	101	111	121	131

All modules with PK4 panels (transparent solid polycarbonate, clear/smoky, thickness of 4 mm with UV protection)

### Wide range of colours



### Custom production options

- ➔ Custom dimensions of enclosure
- ➔ Selection of the panel type and colour
- ➔ Always consult the manufacturer for the type and location of the door
- ➔ Completely individual configuration
- ➔ Choice of more than 40 colours and patterns of the supporting structure

# MIAMI

custom

## Enclosure construction

- ➔ Highly resistant XL profiles
- ➔ Rounded shape
- ➔ Undergoes tough stress tests



## Compact polycarbonate

- ➔ UV stabilization
- ➔ 4 mm thick
- ➔ Protects the pool perfectly



## Air XL rail

- ➔ Axial distance 110 mm, height 20 mm
- ➔ Fully walkable
- ➔ Hidden anchoring elements





[uima-altaita.fi](http://uima-altaita.fi)



*Rentoudu vedessä*

# MONACO FUTURE

The walk-under enclosure MONACO FUTURE becomes a unique decorative feature of each garden. Have a fun with your friends at the swimming pool, play with your children in water, improve your fitness by swimming or just relax peacefully regardless of the weather outside. You can do anything with the MONACO FUTURE enclosure.



# MONACO FUTURE

custom

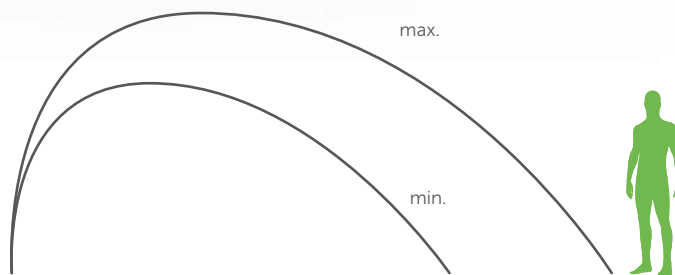

Custom Monaco Future – possible dimensions								
outer width up to (cm)	profile type	minimum height for the specified number of modules (cm)						
		1 module	2 modules	3 modules	4 modules	5 modules	6 modules	7 modules
351-400	L	200	200	200	200	200	200	200
450	L	200	200	200	200	200	200	200
500	L	200	200	200	200	200	200	200
550	L+	210	210	210	210	210	210	210
600	L+	210	210	210	210	210	220	220

All modules with PK4 panels (transparent solid polycarbonate, clear/smoky, with a thickness of 4 mm with UV protection) or PK8 (tube polycarbonate, clear/smoky, with a thickness of 8 mm with UV protection)



# MONACO FUTURE

custom



## Enclosure structure

- > highly durable profiles
- > rounded shape
- > undergoes demanding stress tests

The Air track can be walked on, is easy to sink into the ground and has hidden anchoring elements.

The rollers, with their stainless steel encapsulated bearings, slide easily. Hooks against lifting the modules are included.

When looking at the front wall of the largest module, this is the left design

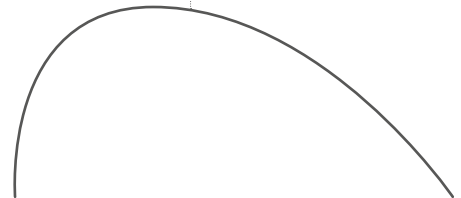

When looking at the front wall of the largest module, this is the right design

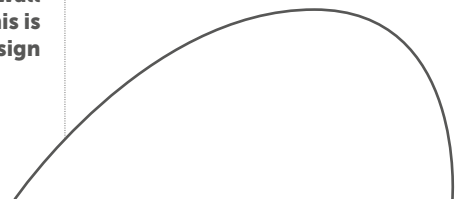

## Wide range of colours



according to the current sample book

## Custom production options

- ➔ Custom dimensions of enclosure
- ➔ Selection of the panel type and colour
- ➔ Always consult the manufacturer for the type and location of the door
- ➔ Completely individual configuration
- ➔ Choice of more than 40 colours and patterns of the supporting structure





# SYDNEY

SYDNEY - this is a design enclosure that we have developed for you in cooperation with automotive designers. Not only experts will appreciate the ultra-low profile, elegant curves and unique look.



# SYDNEY/SYDNEY CLEAR

## serial

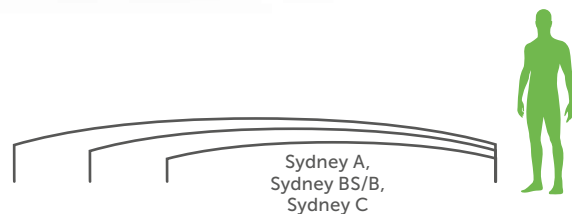
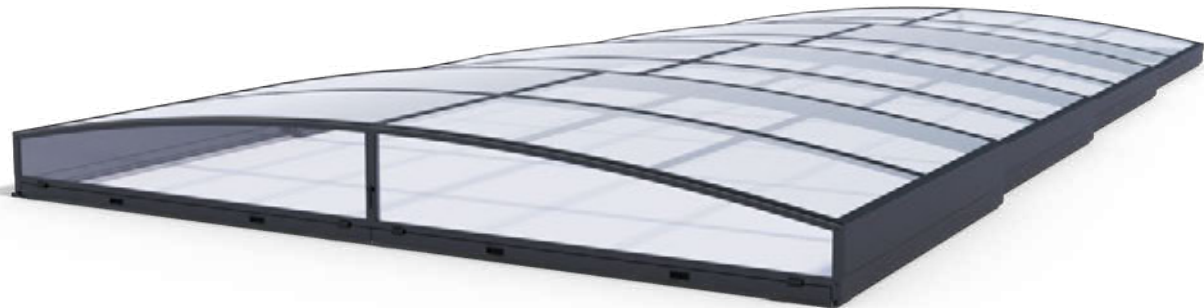

Model	Sydney A	Syd. Clear A	Syd. BS	Syd. Clear BS	Sydney B	Syd. Clear B	Sydney C	Syd. Clear C
Maximum covered area	350 x 635 cm		400 x 740 cm		400 x 850 cm		450 x 850 cm	
Number of modules	3	3	4	4	4	4	4	4
Outer width "B"	386 cm	386 cm	450 cm	450 cm	450 cm	450 cm	500 cm	500 cm
Outer width "A"	358 cm	358 cm	408 cm	408 cm	408 cm	408 cm	458 cm	458 cm
Outer length "E"	646 cm	646 cm	752 cm	752 cm	860 cm	860 cm	860 cm	860 cm
Outer height "V"	48 cm	48 cm	56 cm	56 cm	56 cm	56 cm	58 cm	58 cm
Side entrance	X	X	X	X	X	X	X	X
Module panels	PK8 <sup>1)</sup>	PK4 <sup>2)</sup>	PK8 <sup>1)</sup>	PK4 <sup>2)</sup>	PK8 <sup>1)</sup>	PK4 <sup>2)</sup>	PK8 <sup>1)</sup>	PK4 <sup>2)</sup>
Front head	fixed	fixed	fixed	fixed	fixed	fixed	fixed	fixed
Front head panels	PK4 <sup>2)</sup>	PK4 <sup>2)</sup>	PK4 <sup>2)</sup>	PK4 <sup>2)</sup>	PK4 <sup>2)</sup>	PK4 <sup>2)</sup>	PK4 <sup>2)</sup>	PK4 <sup>2)</sup>
Rear head	fixed	fixed	fixed	fixed	fixed	fixed	fixed	fixed
Rear head panels	PK4 <sup>2)</sup>	PK4 <sup>2)</sup>	PK4 <sup>2)</sup>	PK4 <sup>2)</sup>	PK4 <sup>2)</sup>	PK4 <sup>2)</sup>	PK4 <sup>2)</sup>	PK4 <sup>2)</sup>
Higher lower edge of heads	6 cm	6 cm	6 cm	6 cm	6 cm	6 cm	6 cm	6 cm
Supporting profiles	L	L	L	L	L	L	L+	L+
Track	AIR single-sided, only 1 rail							
Module locking	lockable							
Colour	DB703	DB703	DB703	DB703	DB703	DB703	DB703	DB703
BOX package size	445 x 60 x 150 cm		561 x 60 x 150 cm		561 x 60 x 150 cm		561 x 60 x 150 cm	
BOX package weight	459 kg	654 kg	613 kg	742 kg	623 kg	752 kg	651 kg	812 kg

<sup>1)</sup> PK8 – transparent tube polycarbonate with a thickness of 8 mm with UV protection.

<sup>2)</sup> PK4 = transparent clear polycarbonate with a thickness of 4-mm with UV protection

### Elegant colour design



### Main advantages of ALBIXON BOX

- ➔ Goods for immediate dispatch
- ➔ Quick and easy installation
- ➔ Packaging variability

# SYDNEY/SYDNEY CLEAR

## technical details

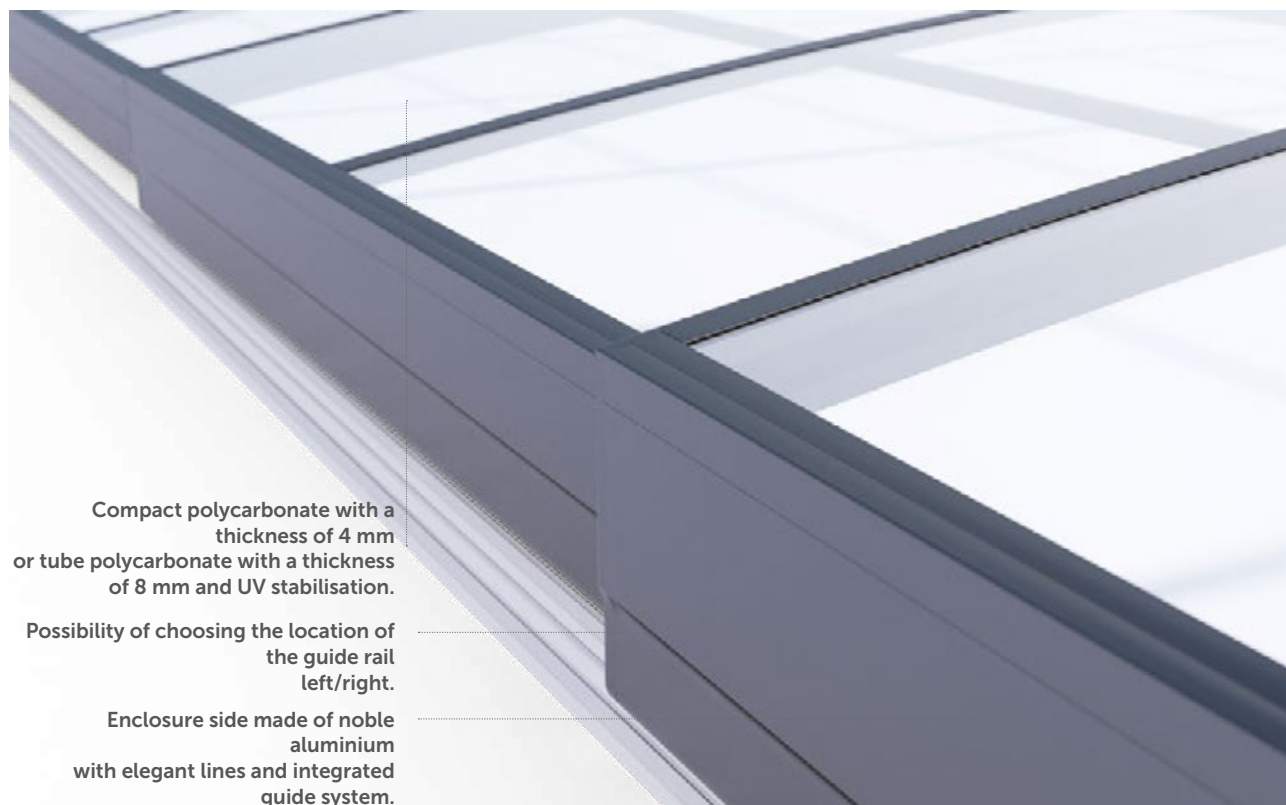

### Fewer rails, more comfort!

For maximum ergonomics, the Sydney enclosure is equipped with only one guide rail allowing for the movement of the largest module. The other modules are railless. The guide rail can be installed on the left or right (when looking at the largest module from the front). The rail is not sunk into the ground. The Sydney enclosure is too low for swimming. Therefore, we recommend extending the track by min. 250 cm.

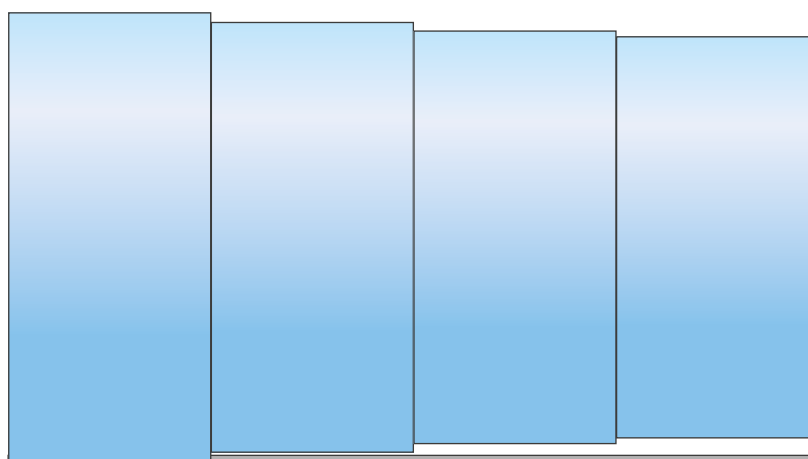

# Profiles and rails

## Supporting profiles

### M profiles

These are profiles for small and medium enclosures. Elegantly rounded and firm inside and out.

**Cross-section 40 x 55 mm.**



### L profiles

They are suitable for medium-sized enclosures. They have the same appearance as M profiles, but their structure is reinforced.

**Cross-section 40 x 55 mm.**

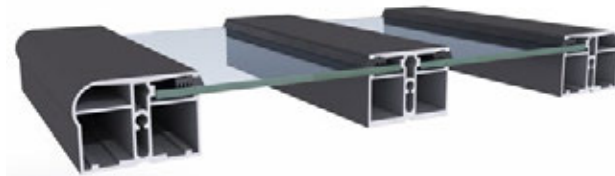

### L+ profiles

Profiles for large enclosures. The middle profile is larger compared to the L series.

**Cross-section 40 x 55 mm and 40 x 72 mm.**

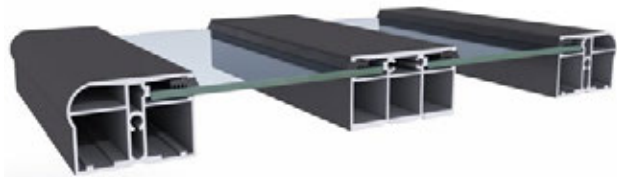

### XL profiles

This profile series is designed for the largest enclosures, where there is an emphasis on uncompromising durability.

**Cross-section 73 x 55 mm.**



## Track

### AIR track

They are suitable for enclosures made from M, L, and L+ profiles. They represent a unique solution with hidden anchor bolts. We offer a version for enclosures with a low and high impact angle.

**Height 20 mm, pitch 70 mm.**



### AIR track 110 mm

Air track version for use with XL profiles. The STANDARD 110-mm track is used for the DALLAS and KLASIK XL models.

**Height 20 mm, pitch 110 mm.**

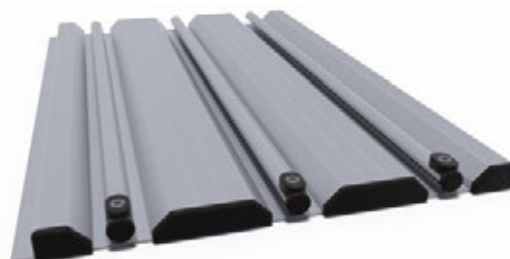

# Panels and Colours

## Profile colours

We use highly resistant powder paints for enclosure structures, which we apply in our own paint shop. In addition to the standard Silver Elox and Antracit DB703, other colours from our sample book are also popular, as well as design patterns that can be adapted to the colour of your house or window frames.

In the case of standard enclosures, the colours are given. The colour solutions for custom structures are as follows:

### Category 1

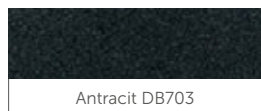

### Category 3

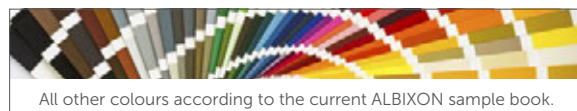

### Category 2

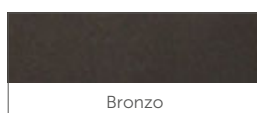
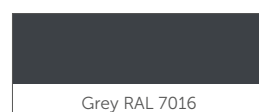
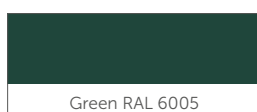
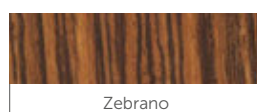
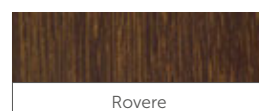
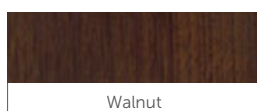
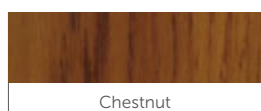
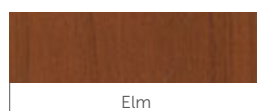
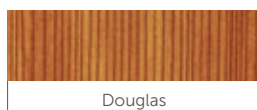
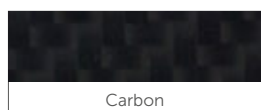
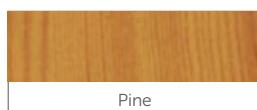

## Panels

### Tube polycarbonate

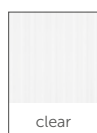

We use 8-mm tube polycarbonate for the panels in M, L and L+ profiles. For the XL profile, we use module panels with a thickness of 10 mm (the heads of the enclosure being made of 8-mm panels). This panel is characterised by extreme durability and high insulation capacity. UV protection as a matter of course. There are two colours to choose from.

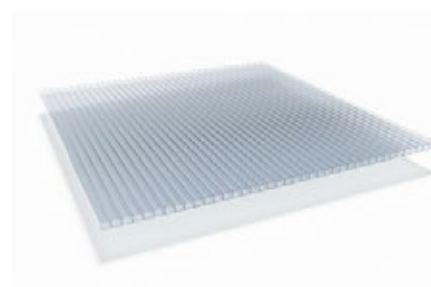

### Transparent panel

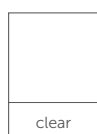

As standard, we use transparent boards made of solid polycarbonate or SAN with a thickness of 4 mm. This panel is characterised by its elegant appearance and perfect transparency. UV protection as a matter of course.



\*not available for SAN

# Enclosure details

## Front and back panels

- Fixed
- Removable

The front and back panels of the enclosure can be fixed with screws or attached removably using a panel screw. We recommend removable panels when the enclosure cannot be fully slid out of the swimming pool area and you commonly swim under. The removable panel can be fitted with lockable panel screws. Depending on size, the panel can be made as a single piece or in multiple pieces.

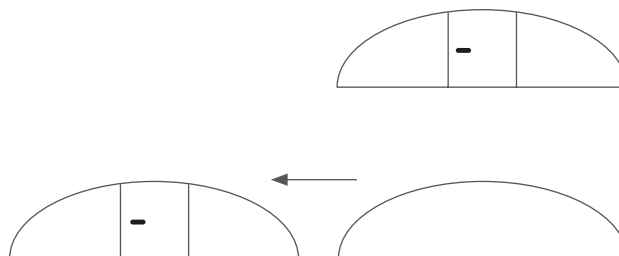

## Elevated bottom panel edges

This detail facilitates smooth movement of the enclosure for example over an elevated pool border. We offer an elevation of the bottom panel edge, covered by a durable canvas, up to 15 cm. If the elevation is higher, the sealing of the enclosure will be impaired.

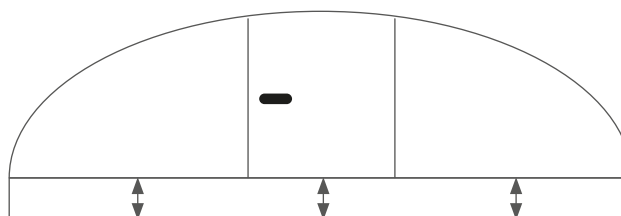

## Clapper

The lower part of the front panel is slanted upwards for easy crossing of the enclosure over obstacles, such as stairs or a spring-board. The maximum clapper height is up to half the height of the front/back panel. ATTENTION! There can't be any door in the panel with clapper. We always recommend consulting on the use of a clapper.

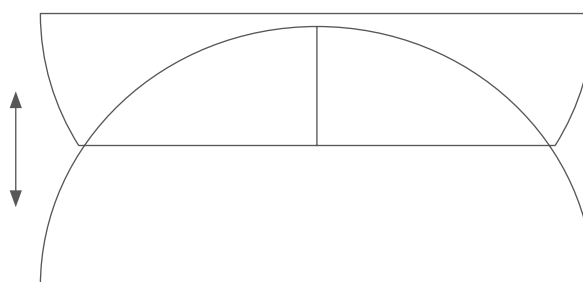

## Side entrance

It is usually located on the biggest module. It can be placed in 4 module quadrants. The side entrance is lockable, of course.

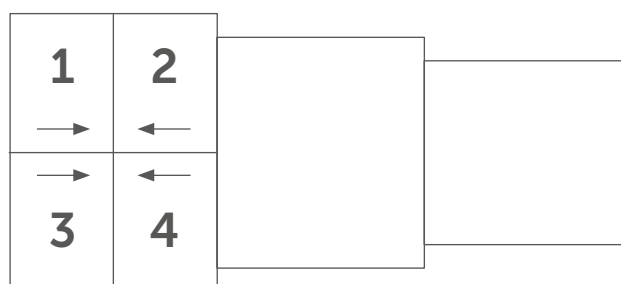

## Doors in front/back panels

- Hinged (left, right)
- Sliding (lift, right)
- Double-wing (hinged, sliding)

They can be hinged or sliding. The standard width is 80 cm for single-wing and 120 cm for double-wing doors. If the required door width exceeds 90 cm and 140 cm for singledoor and double-wing doors, respectively, we recommend using the sliding variant for better stability. We also recommend sliding doors for higher enclosures. We do not recommend a door in the front/back panel of the Casablanca Infinity enclosure. If a hinged door is positioned off -centre, the hinges need to be placed on the side of the door closer to the axis. Doors are available in versions with a doorsill or without.

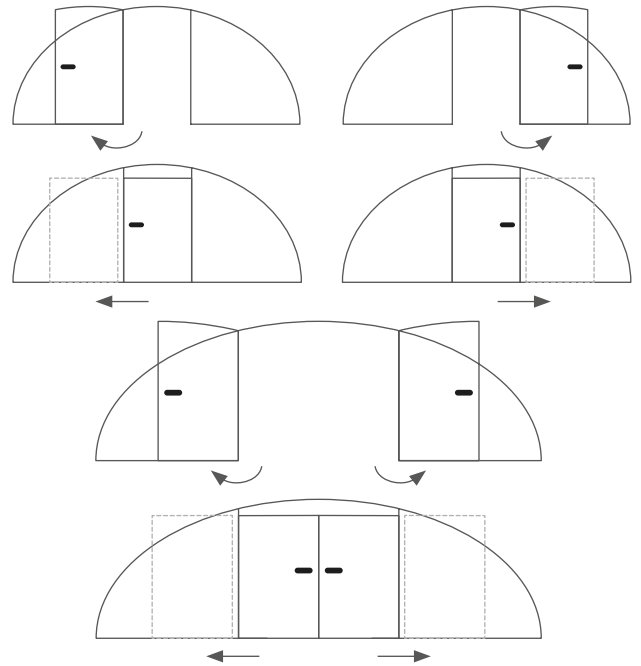

## Stoppers

- Non-lockable
- Lockable

As a standard, each module is supplied with two stoppers in its open/close position. For even higher safety, the stoppers can be lockable. The stoppers are controlled outside of the enclosure as a standard except of the smallest module where a user control the stopper inside due to safety reasons - when the user has been locked inside the enclosure he can open the module there.



## Module length

The enclosure modules have a standard length of 219 cm, unless specified otherwise. The recommended module length ranges between 180 and 250 cm. We do not recommend any other size in order to preserve smooth enclosure movement. We recommend only standard sizes of the Casablanca Infinity enclosure modules. It might be necessary to add supporting arches to maintain a certified loading capacity when a longer length has been decided.

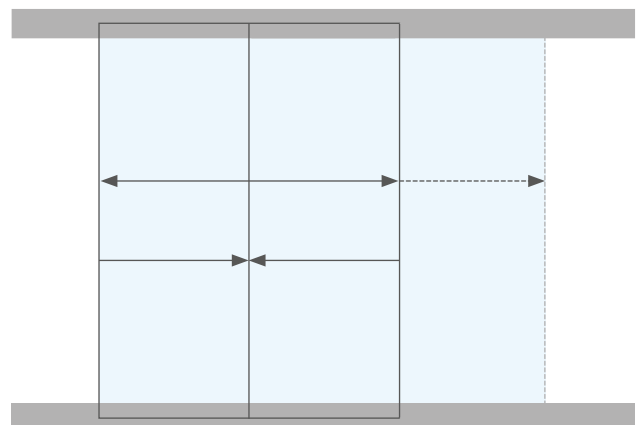



# Accessories





# INVERBOOST PX HEAT PUMPS

The PX models are the flagship among heat pumps. These devices with inverters are characterised by very quiet operation while maintaining maximum performance and efficiency. They are controlled via a touch screen or remotely via Wi-Fi. They work in three modes, Eco, Normal and Boost, so you can choose the speed of the water heating and thus electricity consumption. The use of the ecological coolant R32 is a matter of course.



Model		XHPFD 100 PX	XHPFD 140 PX
Max. heat output	kW	9.5	13.5
Max. input	kW	1.51	2.14
Max. heating factor	COP	16	16
Voltage	V	220-240	220-240
Nominal current	A	6.7	9.5
Recommended pool volume	m <sup>3</sup>	12-34	16-65
Recommended water flow rate	m <sup>3</sup> .h <sup>-1</sup>	2.9	4.2
Diameter of inlet/outlet water piping	mm	50	50
Optional touch screen		✓	✓
Optional Wi-Fi connection		✓	✓
Cooling function		✓	✓
Noise at 10 m	dB(A)	25	28
Noise at 1 m	dB(A)	32-46	34-48
Water pressure	kPa	12	15
Coolant	g	650	840
Type of coolant		R32	R32
Invertor		✓	✓
Net dimensions	mm	855 x 325 x 565	986 x 352 x 672
Net weight	kg	68	78
Package dimensions	mm	942 x 375 x 695	1073 x 402 x 805
Gross weight	kg	73	83

# INVERBOOST C HEAT PUMPS

The INVERBOOST C series is an inverter series of heat pumps with comfortable control. The inverter works in three modes: Eco, Normal and Boost. You can choose the heating rate and thus the electricity consumption. By adding a touch screen and Wi-Fi connection, you can control the device from your mobile phone. The ecological coolant R32 is used.



Model		"INVERBOOST C XHPFDPLUS 100 E"	"INVERBOOST C XHPFDPLUS 160 E"
Max. heat output	kW	9	16
Max. input	kW	1.55	2.67
Max. heating factor	COP	13	13
Voltage	V	220-240	220-240
Nominal current	A	6.65	11.31
Recommended pool volume	m <sup>3</sup>	0-40	25-65
Recommended water flow rate	m <sup>3</sup> · h <sup>-1</sup>	3	5
Diameter of inlet/outlet water piping	mm	50	50
Optional touch screen		✓	✓
Optional Wi-Fi connection		✓	✓
Cooling function		✓	✓
Noise at 10 m	dB(A)	32-44	33-44
Noise at 1 m	dB(A)	40-52	41-56
Water pressure	kPa	15	15
Coolant	g	650	1100
Type of coolant		R32	R32
Invertor		✓	✓
Net dimensions	mm	1008 x 380 x 577	1050 x 440 x 709
Net weight	kg	56	78
Package dimensions	mm	1095 x 430 x 705	1130 x 470 x 850
Gross weight	kg	68	83

# XHPFDPLUS HEAT PUMPS

Powerful XHPFDPLUS heat pumps are the mainstays in our offer. Now with a modern look and the optional touch screen and Wi-Fi connection. Most versions use the ecological coolant R32.



Model		XHPFDPLUS 60	XHPFDPLUS 100	XHPFDPLUS 140	XHPFDPLUS 160	XHPFDPLUS 200
Max. heat output	kW	5	9	12	15	18
Max. input	kW	0.8	1.44	1.92	2.40	2.88
Max. heating factor	COP	6.25	6.25	6.25	6.25	6.25
Voltage	V	220-240	220-240	220-240	220-240	220-240/380-400
Nominal current	A	4.5	7.1	9.5	9.5	14.2
Recommended pool volume	m <sup>3</sup>	0-20	25-40	35-60	40-65	60-90
Recommended water flow rate	m <sup>3</sup> · h <sup>-1</sup>	2.5~3.2	2.8~5.6	3.5~7.1	4~7.9	5.6~11.2
Diameter of inlet/outlet water piping	mm	50	50	50	50	50
Optional touch screen		✓	✓	✓	✓	✓
Optional Wi-Fi connection		✓	✓	✓	✓	✓
Cooling function		✓	✓	✓	✓	✓
Noise at 10 m	dB(A)	35	36	37	42	42
Noise at 1 m	dB(A)	44	45	46	51	51
Water pressure	kPa	12	15	15	15	16
Coolant	g	500	650	850	900	1700
Type of coolant		R32	R32	R32	R32	R410a
Invertor		X	X	X	X	X
Net dimensions	mm	935 x 360 x 545	935 x 360 x 545	1045 x 410 x 695	1045 x 410 x 695	1045 x 410 x 850
Net weight	kg	44	51	61	72	100
Package dimensions	mm	1060 x 380 x 590	1060 x 380 x 590	1140 x 430 x 740	1140 x 430 x 740	1140 x 430 x 990
Gross weight	kg	47	55	65	76	110

# Swim jets

Would you like to swim in your own Olympic-sized swimming pool but your garden is too small? The ELEGANCE swim jet is here for you. It will enable you to practice your swimming endurance even in a small pool and to push the limits of your abilities further and further. ELEGANCE will be appreciated by your entire family because of its easy control directly from the pool and continuous output adjustment.



**Electric circuit breaker**  
For safe connection to a power grid

Model	Elegance 70	Elegance 80	Elegance 95
Voltage	230/400 V	400 V	400 V
Output	70 m <sup>3</sup> /h	80 m <sup>3</sup> /h	95 m <sup>3</sup> /h
Input	2,2 kW	3 kW	4 kW
Jet diameter	40 mm	40 mm	40 mm
Pipe diameter	75 mm	75 mm	75 mm

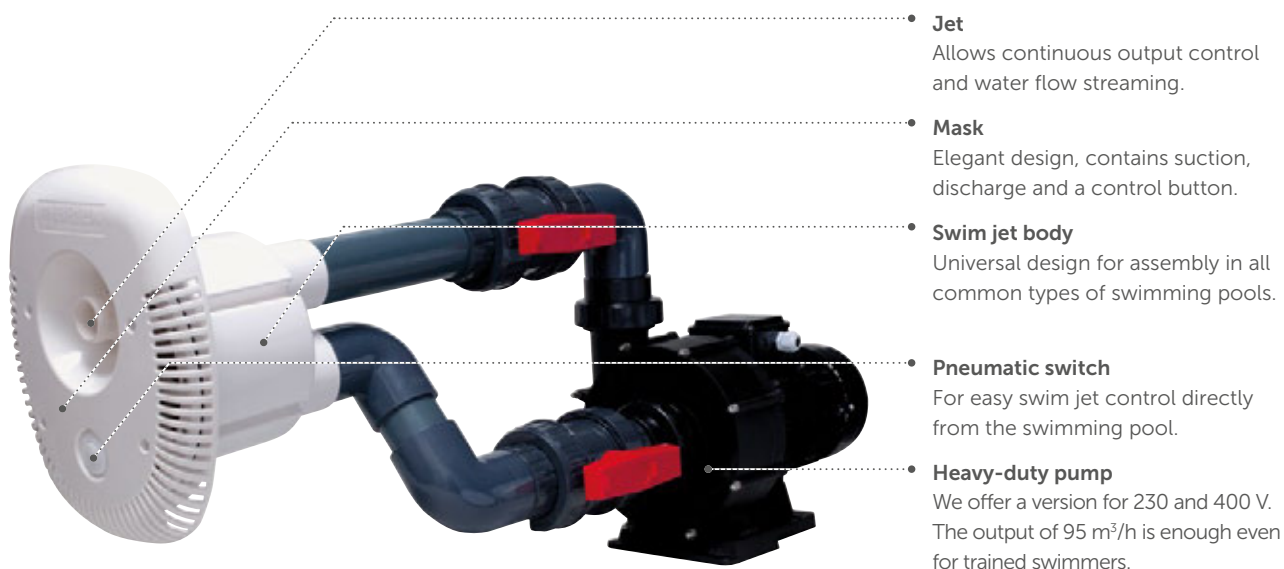

# OXILIFE SALT DISPENSERS

If an OXILIFE salt dispenser is used, both electrolysis and hydrolysis take place. This process forms oxidants from the pool water that help to improve disinfection. In addition, the OXILIFE salt dispenser controls and automatically adjusts the pH of the pool water to an ideal value. It can be complemented with a Redox module or free chlorine. The Wi-Fi module is often added, as it allows remote control of the salt dispenser via the Internet. The OXILIFE salt dispenser can control up to four other pool devices. You can use it to start the filter and heat pumps, or turn on the pool lighting. The touch control display can be placed separately from the salt dispenser and connected by cable with a possible extension using an adapter.



- **Control unit**  
The heart of the system with wide expansion options.
- **Touch display**  
For intuitive operation, optionally with a 20-m cable for any desired location.
- **Electrolytic cell**  
Salt water is converted into free chlorine here.
- **Sleeve**  
For easy installation of sensors in piping.
- **Dosing pump**  
It is used to control the pH of the water to a desirable value.
- **pH probe**  
For automatic control of the dosing pump.
- **Temperature sensor**  
Measuring water temperature.

## Advantages of OXILIFE water treatment

- ➔ Does not dry the skin
- ➔ Double water treatment by electrolysis and hydrolysis
- ➔ Low operating costs
- ➔ Clear water without excessive odour
- ➔ No handling and/or storage of chlorine
- ➔ Ecological system – salt is a natural product
- ➔ Slightly salty water

TECHNICAL PARAMETERS	OXILIFE
Power intensity	0/100%
Max. production of Cl <sub>2</sub>	X
Salt concentration	1.5 to 100g NaCl . l-1
Pool volume (up to 28 °C)	60 m <sup>3</sup>
Pool volume (+ 28 °C)	40 m <sup>3</sup>
Display	Colour 2.8" TFT
Power supply	220V 50/60 Hz
Output	8-15 A
Max. consumption	120 W
Dimensions	270 x 220 x 115 mm
Automatic cleaning	Programmable from 1 to 24 hours
Flow rate switch	Gas
Alarms	- insufficient amount of salt, - no flow, - low / high pH values, - max. pH measurement time, - memory error
Salt concentration display	Salt detection in g.l-1 (± 10 %)
Electrolytic cell	4 titanium plates of MONOPOLAR cell
Minimum flow	5 m <sup>3</sup> . h-1
Tube connection diameter	63 mm
Maximum pressure	4 kg . cm-2
Maximum temperature	45 °C
Probe lifetime	8000 hours of operation
Self-cleaning	YES
Communication	MODBUS/Wi-Fi
Control of main outputs	- filtration time, - lighting, - temperature
Control of additional outputs	4 relays controlling other devices

AUTOMATIC CHECKS	HIDROLIFE
pH PROBE <sup>1)</sup>	It detects the pH of the water so that the salt dispenser can automatically adjust the pH to the desired value. Measuring range: 0-14 ± 0.1 pH.
TEMPERATURE <sup>1)</sup>	Detects the water temperature to be shown on the display. Measurement range: 0-100 ± 1 °C.
REDOX <sup>2), 3)</sup>	"It is used to determine the water purity status for setting the electrolysis performance (on/off). Packaging: REDOX probe, calibration solutions and accessories for installation. Measuring range: 0-1000 ± 3 mV"
FREE CHLORINE <sup>2), 3)</sup>	It is used to determine the water purity status for setting the electrolysis performance (on/off). Measuring range: 0-10 ± 0.1 ppm.
CONDUCTIVITY <sup>2)</sup>	"It is used to determine the salt content in the water. Packaging: probe and installation accessories. Measuring range: 0-20,000 ± 0.1 MS"

1) The device is part of the basic equipment

2) Optional device

3) Either REDOX or FREE CHLORINE; the probes cannot be used at the same time

1 module = probe + chip (the chip remains and the probe is replaced, depending on the service life).

The pH and REDOX probes are consumer products with a limited service life.



# HIDROLIFE SALT DISPENSERS

The HIDROLIFE salt dispenser controls and automatically adjusts the pH of the pool water to an ideal value. It can be complemented with a Redox module or free chlorine. The Wi-Fi module is often added, as it allows remote control of the salt dispenser via the Internet. The HIDROLIFE salt dispenser can control up to four other pool devices. You can use it to start the filter and heat pumps, or turn on the pool lighting. The touch control display can be placed separately from the salt dispenser and connected by cable with a possible extension using an adapter. The touch control display can be placed separately from the salt dispenser and connected by cable with a possible extension using an adapter.



- **Control unit**  
The heart of the system with wide expansion options.
- **Touch display**  
For intuitive operation, optionally with a 20-m cable for any desired location.
- **Electrolytic cell**  
Salt water is converted into free chlorine here.
- **Sleeve**  
For easy installation of sensors in piping.
- **Dosing pump**  
It is used to control the pH of the water to a desirable value.
- **pH probe**  
For automatic control of the dosing pump.
- **Temperature sensor**  
Measuring water temperature.

## Advantages of water treatment

- ➔ Does not dry the skin
- ➔ Low operating costs
- ➔ Clear water without excessive odour
- ➔ No handling and/or storage of chlorine
- ➔ Ecological system – salt is a natural product
- ➔ Slightly salty water

TECHNICAL PARAMETERS	HIDROLIFE
Power intensity	X
Max. production of Cl <sub>2</sub>	16 g.h <sup>-1</sup>
Salt concentration	3 to 100 g NaCl . l <sup>-1</sup>
Pool volume (up to 28 °C)	65 m <sup>3</sup>
Pool volume (+ 28 °C)	40 m <sup>3</sup>
Display	Colour 2.8" TFT
Power supply	220V 50/60 Hz
Output	8-15 A
Max. consumption	120 W
Dimensions	270 x 220 x 115 mm
Automatic cleaning	Programmable from 1 to 24 hours
Flow rate switch	Gas
Alarms	" - insufficient amount of salt, - no flow, - low / high pH values, - max. pH measurement time, - memory error"
Salt concentration display	Salt detection in g.l <sup>-1</sup> (± 10 %)
Electrolytic cell	4 titanium plates of MONOPOLAR cell
Minimum flow	5 m <sup>3</sup> . h <sup>-1</sup>
Tube connection diameter	63 mm
Maximum pressure	4 kg . cm <sup>-2</sup>
Maximum temperature	45 °C
Probe lifetime	8000 hours of operation
Self-cleaning	YES
Communication	MODBUS/Wi-Fi
Control of main outputs	" - filtration time, - lighting, - temperature"
Control of additional outputs	4 relays controlling other devices

AUTOMATIC CHECKS	HIDROLIFE
pH PROBE <sup>1)</sup>	It detects the pH of the water so that the salt dispenser can automatically adjust the pH to the desired value. Measuring range: 0-14 ± 0.1 pH.
TEMPERATURE <sup>1)</sup>	Detects the water temperature to be shown on the display. Measurement range: 0-100 ± 1 °C.
REDOX <sup>2) 3)</sup>	It is used to determine the water purity status for setting the electrolysis performance (on/off). Packaging: REDOX probe, calibration solutions and accessories for installation. Measuring range: 0-1000 ± 3 mV
FREE CHLORINE <sup>2) 3)</sup>	It is used to determine the water purity status for setting the electrolysis performance (on/off). Measuring range: 0-10 ± 0.1 ppm.
CONDUCTIVITY <sup>2)</sup>	It is used to determine the salt content in the water. Packaging: probe and installation accessories. Measuring range: 0-20,000 ± 0.1 MS

1) The device is part of the basic equipment

2) Optional device

3) Either REDOX or FREE CHLORINE; the probes cannot be used at the same time

1 module = probe + chip (the chip remains and the probe is replaced, depending on the service life).

The pH and REDOX probes are consumer products with a limited service life of six months.

# NEOSAL SALT DISPENSERS

Salt water is healthy and does not irritate the human eye or skin. A small amount of free chlorine is obtained from the salt water in the pool by electrolysis, which is sufficient for quality disinfection of the pool. The free chlorine thus formed is transformed into salt again after a short time.

The NEOSAL salt dispenser controls the intensity of the formation of free chlorine generated in the electrolytic cell on the basis of the manual setting on the display. The touch control display can be placed separately from the salt dispenser and connected by cable with a possible extension using an adapter.



## Control unit

## Electrolytic cell

Salt water is converted into free chlorine here.

TECHNICAL PARAMETERS	NEOSAL
Power intensity	X
Max. production of Cl <sub>2</sub>	16 g.h <sup>-1</sup>
Salt concentration	4 to 100g NaCl . l <sup>-1</sup>
Pool volume (up to 28 °C)	65 m <sup>3</sup>
Pool volume (+ 28 °C)	40 m <sup>3</sup>
Display	Colour 1.44" TFT
Power supply	220V 50/60 Hz
Output	8-15 A
Max. consumption	120 W
Dimensions	270 x 220 x 115 mm
Automatic cleaning	Programmable from 1 to 24 hours
Flow rate switch	Gas
Alarms	- insufficient amount of salt - no flow - memory error
Salt concentration display	No
Electrolytic cell	4 titanium plates of MONOPOLAR cell
Minimum flow	5 m <sup>3</sup> . h <sup>-1</sup>
Tube connection diameter	63 mm
Maximum pressure	4 kg . cm <sup>-2</sup>
Maximum temperature	45 °C
Lifetime	8000 hours of operation
Self-cleaning	YES
Control of main outputs	No
Control of additional outputs	No

# UV Lamps

The use of the SP UV lamp is a smart way to keep the pool water clean without the use of chlorine. Before returning to the pool, all filtered water passes through the body of the UV lamp, where it is exposed to UV radiation. This eliminates any harmful germs or bacteria and the water in your pool is clean without the use of any chemicals.

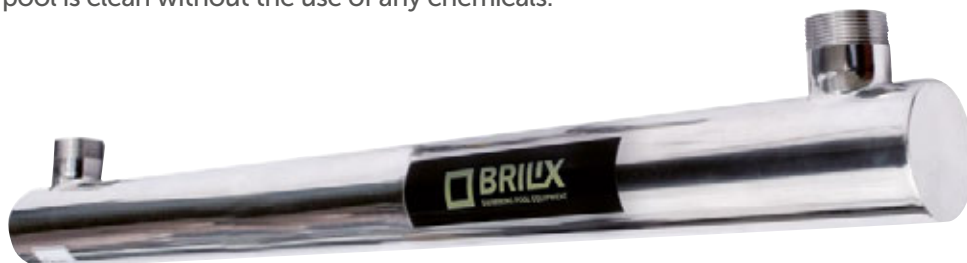

Model	SP - I	SP - II	SP - III	SP - IV	SP - V
A (mm)	267	786	786	786	786
B (mm)	175	175	175	175	175
C (mm)	155	155	155	155	155
D (mm)	420	930	930	930	930
Pipe diameter	50 mm	50 mm	50 mm	50 mm	50 mm
Voltage	230 V	230 V	230 V	230 V	230 V
Input	16 W	40 W	65 W	85 W	2 x 85 W
Minimum flow rate	6 m <sup>3</sup> /h	9 m <sup>3</sup> /h	12 m <sup>3</sup> /h	15 m <sup>3</sup> /h	20 m <sup>3</sup> /h
Maximum pressure	3 bar	3 bar	3 bar	3 bar	3 bar
For pools up to	15 m <sup>3</sup>	35 m <sup>3</sup>	55 m <sup>3</sup>	70 m <sup>3</sup>	140 m <sup>3</sup>

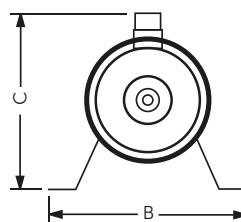
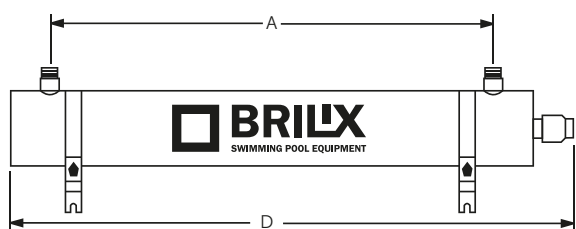

Stainless steel UV lamps cannot be used in saltwater pools.



- Stainless steel**  
 Ensures maximum resistance of the equipment in the most challenging conditions.
- Quartz tube**  
 For excellent protection of the UV lamp.
- UV lamp**  
 Heart of the device which provides the water treatment.

# Circulation pumps

The circulation pump is a standard element of swimming pool technology. To keep water in the swimming pool crystal clear, it is necessary to filter at least four times a day. We therefore offer filtration pumps for all regular swimming pool sizes.

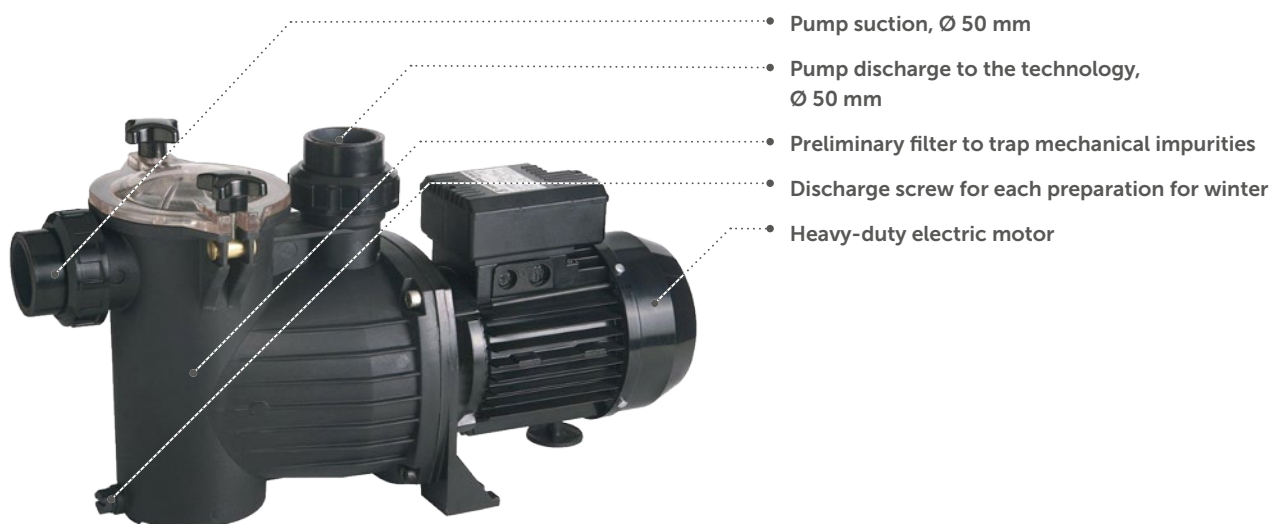

## Circulation pumps PREVA

Model	PREVA 33	PREVA 50	PREVA 75
Output	6 m <sup>3</sup> /h	9 m <sup>3</sup> /h	12 m <sup>3</sup> /h
Voltage	230 V	230 V	230 V
Input	0,25 kW	0,33 kW	0,55 kW



## Circulation pumps BRILIX

Model	FXP 150	FXP 250	FXP 370	FXP 550	FXP 750
Output	10 m <sup>3</sup> /h	11,6 m <sup>3</sup> /h	14 m <sup>3</sup> /h	15 m <sup>3</sup> /h	16 m <sup>3</sup> /h
Voltage	230 V	230 V	230 V	230 V	230 V
Input	0,2 kW	0,25 kW	0,5 kW	0,75 kW	1 kW

# Sand filtration

Filtration is a key technology component for each swimming pool. Even if you are not interested in any other technology, water filtering is indispensable. Our offer therefore includes a complete portfolio of Combo filtration systems, separate filters and pumps.

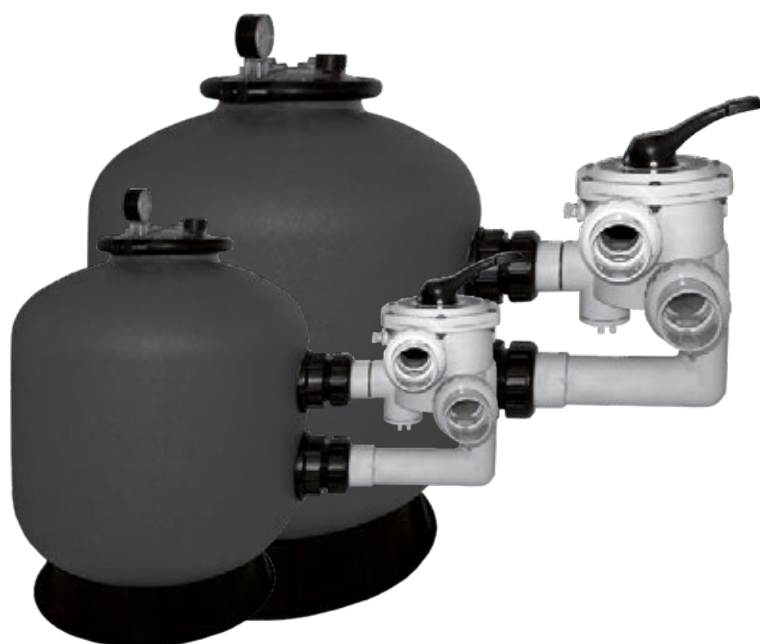

## Filter vessels

We offer models with a six-way valve located at the top or on the side of the vessel and so they are suitable for installation in any spatial conditions.

Model	P 350	P 450	P 500	P 650	SP 450	SP 500	SP 650	SP 700
For pools up to	24 m <sup>3</sup>	36 m <sup>3</sup>	54 m <sup>3</sup>	72 m <sup>3</sup>	36 m <sup>3</sup>	54 m <sup>3</sup>	72 m <sup>3</sup>	96 m <sup>3</sup>
Output	4 m <sup>3</sup> /h	6 m <sup>3</sup> /h	9 m <sup>3</sup> /h	12 m <sup>3</sup> /h	6 m <sup>3</sup> /h	9 m <sup>3</sup> /h	12 m <sup>3</sup> /h	16 m <sup>3</sup> /h
6-way valve	top	top	top	top	top	top	top	top
Sand filling	20 kg	45 kg	85 kg	145 kg	45 kg	85 kg	145 kg	210 kg



### Combo filtration

A unique combination of a sand filter and a circulation pump.

- 6-way valve
- Filtration tank
- Solid base
- Circulation pump

Model	FSP 350	FSP 450	FSP 500	FSP 650
For pools up to	24 m <sup>3</sup>	48 m <sup>3</sup>	72 m <sup>3</sup>	96 m <sup>3</sup>
Output	4 m <sup>3</sup> /h	8 m <sup>3</sup> /h	12 m <sup>3</sup> /h	16 m <sup>3</sup> /h
Voltage	230 V	230 V	230 V	230 V
Input	0,43 kW	0,55 kW	0,75 kW	0,90 kW
Sand filling	20 kg	45 kg	85 kg	145 kg

uima-altaita.fi

Rentoudu vedessä

# Pool vacuum cleaners

## Hayward AquaVac 650 robotic vacuum cleaner

SpinTech technology filter with 18 hydrocyclones. It cleans the bottom and walls thoroughly by means of six variable-speed rollers. Non-contact waste bin with LED signalling. Remote administration using a smartphone. Wi-Fi connection.



## Dolphin S300i robotic vacuum cleaner

Controlled by a microprocessor, optional automatic cleaning of the bottom and walls of the pool as well as optional control using a smartphone application.

## Dolphin E20 robotic vacuum cleaner

Controlled by a microprocessor, optional automatic cleaning of the bottom and walls of the pool.



## Dolphin Spring robotic vacuum cleaner

Controlled by a microprocessor, it automatically cleans the pool and filters the water.



# Other accessories

## Skimmers



**Skimmer 15 x 15**  
ABS plastic, connection to a vacuum cleaner available



**Skimmer 30 x 15**  
ABS plastic, connection to a vacuum cleaner available



**Skimmer 15l**  
ABS plastic, connection to a vacuum cleaner available



**Skimmer SLIM**  
ABS plastic, connection to a vacuum cleaner available, innovative slim design

## Jets

### Jet

with adjustable flow rate and water flow direction, for 50 mm pipes



### Flat jet

with adjustable flow rate and water flow direction, for 50 mm pipes



## Accessories, add-ons and installation material

The complete and always current range for the installation and operation of pools can be found at [ALBIXONPORTAL.com](http://ALBIXONPORTAL.com).



# Lightning

## LED lamp Moonlight PLW300

12 V / 15 W

white, luminous flux 1250 lm



## LED lamp Moonlight PLS300

12 V / 15 W

multi-color, luminous flux 575 lm



## Halogen lamp UL-P100\*

12 V/75 W



## Halogen lamp 300 W\*

12 V/300 W



## LED lamp, LED-P100\*

12 V/8 W

white, blue, multi-color



## Distribution box

for embedding in the ground



## Transformers

230 V/12 V

100, 200 or 300 W



uima-altaita.fi



Rentoudu vedessä

\*While supplies last.

# ALBIXON B2B

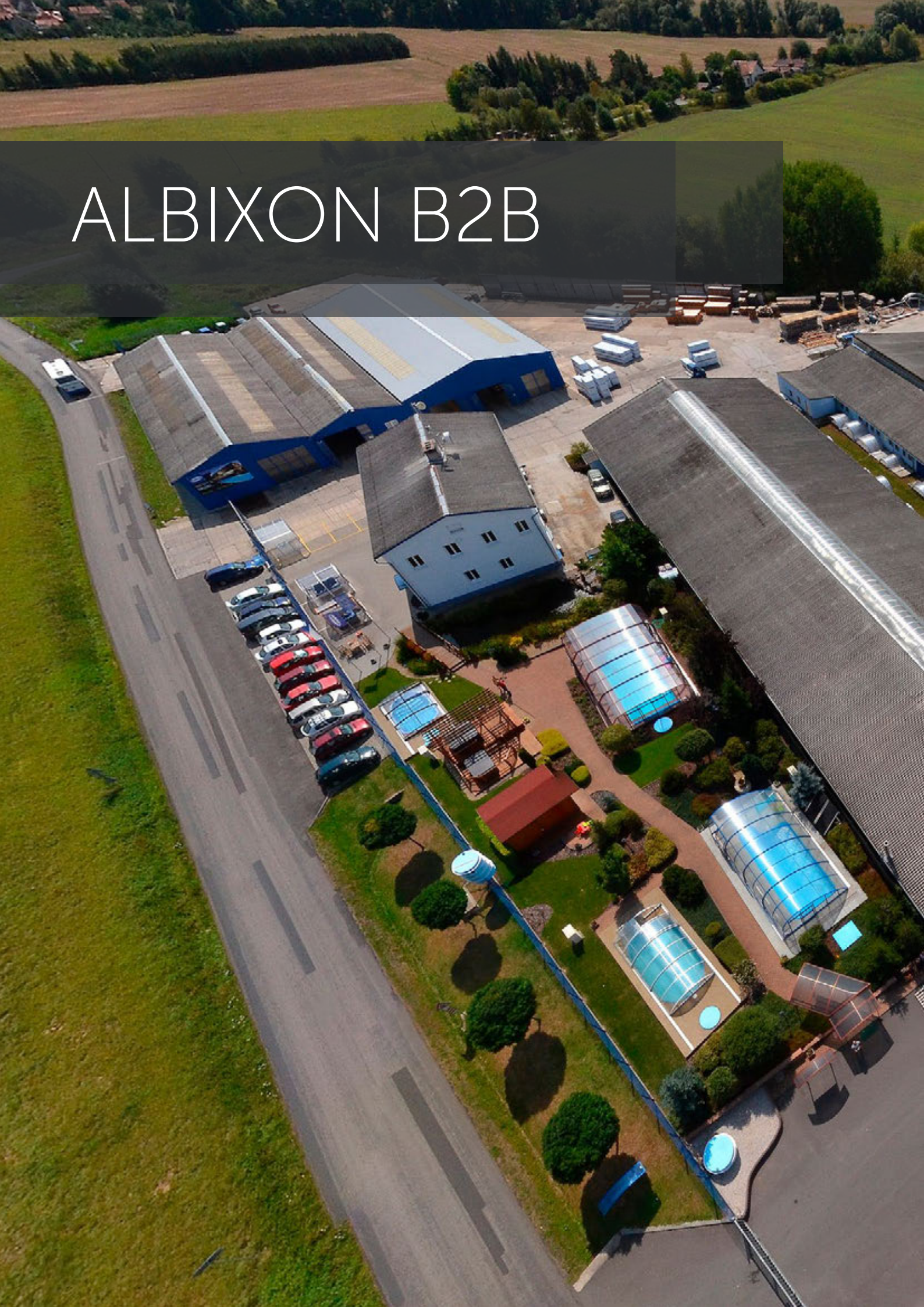





## Why ALBIXON pool enclosure?



- › safety for your children and pets
- › significantly higher water temperature
- › clean water
- › saves time and money on chemicals
- › extended swimming season
- › increases the value of the house

### ALBIXON BOX

optimal delivery time • affordable • simple selection  
 • solution for 95% of swimming pools • easy assembly  
 • competitive price/performance ratio • 3 most widely sold colors • solution tested by decades of use

### Custom enclosures

100% individual solution • broad selection of colors • custom design • ideal solution for atypical pools

## Why BRILIX® accessories?

- › top-quality brand components
- › optimal price/quality ratio
- › innovative solutions for your swimming pool
- › short delivery times within the entire EU
- › full range of products
- › precision output control



# Enclosure logistics

It is crucial not only to produce an enclosure precisely, but also to deliver to the final destination reliably and in time. Backed by years of experience, we offer you transport services across Europe, at very favourable conditions. We use not only our own fleet of trucks, but also services of reliable international forwarders.

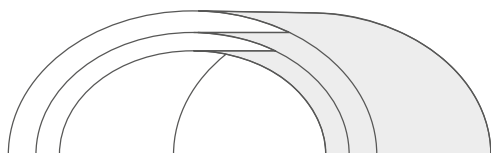

## Assembled enclosures, without packaging

The transport dimensions are determined by an outer width, an outer height and a length of a single enclosure module, with 20 cm added to each of these values. If, for example, an enclosure is 480 cm wide, 120 cm high and one module 219 cm long, the transport dimensions are 500 × 140 × 239 cm (length × height × width). Enclosures higher than 80 cm can also be transported vertically – the transport height and width are then switched. This mode allows a transport of multiple enclosures – do not hesitate to contact us for a specific transport solution.

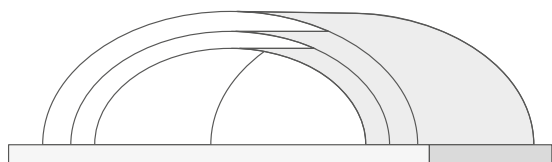

## Assembled enclosures, on pallets

Used for custom enclosures transported in containers. Transport dimensions are determined on the basis of an outer width, an outer height and a length of a single enclosure module, with 15 cm added to each of these values, plus 15 cm length per pallet. If, for example, the enclosure is 480 cm wide, 120 cm high and one module is 219 cm long, the transport dimensions are 495 × 150 × 234 cm (length × height × width).

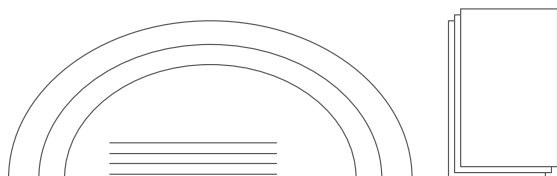

## Disassembled enclosures

Packaging with or without a pallet for enclosures that cannot be transported assembled. The transport dimensions are determined on a case by case basis.

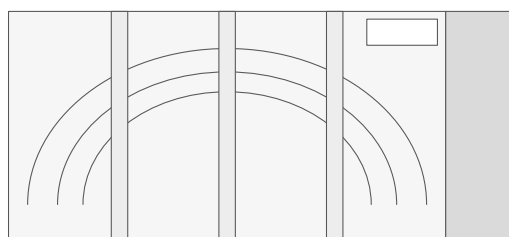

## Boxed enclosures

This packaging represents an economic mode of transport. The transport dimensions of standard products are based on the box dimension. Box sizes of custom enclosures are determined individually. The boxes are always transported in an upright position and cannot be tilted.

## Approximate enclosure transport limits

Means of transport	Maximum dimensions of transported custom enclosure					Number of serial boxes	
	Assembled, horizontal transport	Assembled, vertical transport	Assembled on pallet	Disassembled on pallet	Disassembled in box	Standard	Multibox
<b>Truck - max. 7.5-m loading area</b>	external width up to 730 cm, height up to 270 cm, length of 1 module up to 230 cm	external width up to 730 cm, height up to 230 cm, length of 1 module up to 270 cm	Individual Feel free to contact us for more information.			up to 10 pcs	Individually. Feel free to contact us for more information.
<b>Truck - max. 13.5-m loading area</b>	external width up to 900 cm, height up to 270 cm, length of 1 module up to 230 cm	external width up to 900 cm, height up to 230 cm, length of 1 module up to 270 cm				up to 25 pcs	
<b>20' container</b>	external width up to 570 cm, height up to 200 cm, length of 1 module up to 219 cm	Not possible				up to 10 pcs	
<b>40' container</b>	external width up to 900 cm, height up to 200 cm, length of 1 module up to 219 cm	Not possible				up to 40 pcs	
<b>40' high cube container</b>	outer width up to 900 cm, height up to 220 cm, length of 1 module up to 219 cm	Not possible				up to 40 pcs	

ENCLOSURE	BOX DIMENSIONS	BOX WEIGHT
Casablanca Infinity A	445 x 48 x 127 cm	440 kg
Casablanca Infinity B	561 x 55 x 127 cm	675 kg
Dallas A	445 x 48 x 127 cm	310 kg
Dallas Clear A	445 x 48 x 127 cm	420 kg
Dallas B	561 x 55 x 127 cm	480 kg
Dallas Clear B	561 x 55 x 127 cm	650 kg
Klasik S	430 x 41 x 157 cm	240 kg
Klasik A	430 x 41 x 157 cm	290 kg
Klasik Clear A	430 x 41 x 157 cm	380 kg
Klasik B	563 x 47 x 188 cm	470 kg
Klasik Clear B	563 x 47 x 188 cm	600 kg
Klasik C	606 x 61 x 175 cm	680 kg
Klasik Clear C	606 x 61 x 175 cm	860 kg
Klasik D	680 x 85 x 200 cm	890 kg
Klasik Pro B	561 x 55 x 127 cm	470 kg
Klasik Pro Clear B	561 x 55 x 127 cm	610 kg
Sydney A	445 x 60 x 150 cm	459 kg
*SydneyClear A*	445 x 60 x 150 cm	654 kg
Sydney BS	561 x 60 x 150 cm	613 kg
*SydneyClear BS*	561 x 60 x 150 cm	742 kg
Sydney B	561 x 60 x 150 cm	623 kg
*SydneyClear B*	561 x 60 x 150 cm	752 kg
Sydney C	561 x 60 x 150 cm	651 kg
*SydneyClear C*	561 x 60 x 150 cm	812 kg

SWIMMING POOLS QBIG BENEFIT OVERFLOW		
	1.2 m	1.5 m
3 x 4 m	356 kg	387 kg
3 x 5 m	425 kg	461 kg
3 x 6 m	461 kg	502 kg
3 x 7 m	531 kg	576 kg
3 x 8 m	600 kg	650 kg
3.5x7m	577 kg	624 kg
4 x 8 m	703 kg	757 kg

SWIMMING POOLS QBIG BENEFIT SKIMMER		
	1.2 m	1.5 m
3 x 4 m	246 kg	277 kg
3 x 5 m	300 kg	336 kg
3 x 6 m	321 kg	361 kg
3 x 7 m	375 kg	419 kg
3 x 8 m	429 kg	478 kg
3.5x7m	413 kg	460 kg
4 x 8 m	517 kg	570 kg

SWIMMING POOLS G1 BENEFIT OVERFLOW		
	1.2 m	1.5 m
3 x 4 m	340 kg	376 kg
3 x 5 m	403 kg	444 kg
3 x 6 m	439 kg	485 kg
3 x 7 m	501 kg	553 kg
3 x 8 m	564 kg	621 kg
3.5x7m	577 kg	624 kg
4 x 8 m	703 kg	757 kg

SWIMMING POOLS G1 BENEFIT SKIMMER		
	1.2 m	1.5 m
3 x 4 m	231 kg	263 kg
3 x 5 m	279 kg	315 kg
3 x 6 m	300 kg	340 kg
3 x 7 m	348 kg	393 kg
3 x 8 m	395 kg	445 kg
3.5x7m	379 kg	426 kg
4 x 8 m	467 kg	521 kg





Pool and cover - perfect match



# Technical catalogue 2021

uima-altaita.fi  
*Rentoudu vedessä*

**ALBIXON**

www.ALBIXON.com  
export@ALBIXON.COM  
Made in EU

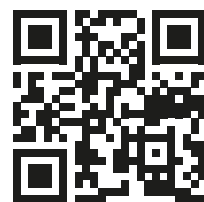

Taking into account possible developments and improvements in products, packaging and processes, ALBIXON a.s. reserves the right to change any data in this catalogue without prior notice. Printing and typesetting errors reserved. v\_01